

Friction Welding

Manufacturing Technology, Inc. 



All of us at MTI...

would like to extend our thanks for your interest in our company. Manufacturing Technology, Inc. has been a leading manufacturer of inertia, direct drive and hybrid friction welders since 1976.

We hope that the following pages will further spark your interest by detailing a number of our products, services and capabilities.

We at MTI share a common goal...to help you solve your manufacturing problems in the most efficient way possible. Combining friction welding with custom designed automation, we have demonstrated dramatic savings in labor and material with no sacrifice to quality. Contact us today to find out what we can do for you.

Table of Contents

Introduction to Friction Welding	2
Advantages of MTI's Process	3
Inertia Friction Welding	4
Direct Drive & Hybrid Friction Welding	5
Machine Monitors & Controllers	6
Safety Features	7
Flash Removal	7
MTI Welding Services	8
Weldable Combinations	9
Applications	
Aircraft/Aerospace	10
Oil Field Pieces	14
Military	16
Bimetallic & Special	20
Agricultural & Trucking	22
Automotive	28
General	38
Special Welders & Automated Machines	46
Machine Models & Capabilities	48

Friction Welding

What It Is

Friction welding is a solid-state joining process that produces coalescence in materials, using the heat developed between surfaces through a combination of mechanically induced rubbing motion and applied load. The resulting joint is of forged quality. Under normal conditions, the faying surfaces do not melt. Filler metal, flux and shielding gas are not required with this process.

Dissimilar Materials

Even metal combinations not normally considered compatible can be joined by friction welding, such as aluminum to steel, copper to aluminum, titanium to copper and nickel alloys to steel. As a rule, all metallic engineering materials which are forgeable can be friction welded, including automotive valve alloys, maraging steel, tool steel, alloy steels and tantalum. In addition, many castings, powder metals and metal matrix composites are weldable.

Savings—Cost, Time, Material

Since dissimilar materials can be joined, a significant cost savings is possible because engineers can design bimetallic parts that use expensive materials only where needed. Expensive forgings and castings can be replaced with less expensive forgings welded to bar stock, tubes, plates and the like.

Substantial time savings are realized since the process is significantly faster than more conventional methods of welding.

Manufacturing Technology, Inc.

(MTI) was founded in 1976 as a company specializing in friction welding. At that time, MTI acquired all available patents, technical specifications, and product development information from Caterpillar Tractor Company for Inertia Welders and AMF's Flywheel Friction Welders. A further addition was made in 1985 when MTI acquired the rights to New Britain's line of Direct Drive Friction Welders. Today, MTI offers a complete line of Inertia, Direct Drive, and Hybrid Direct Drive Friction Welders.

With machines in use around the globe, MTI is a world leader in designing and building inertia and direct drive friction welders by helping major industries solve many of their most complex manufacturing problems. Applications typically friction welded include aircraft and aerospace components, cutting tools, agricultural machinery, automotive parts, oil field pieces, waste canisters, military equipment, spindle blanks and bimetallic materials.

We continue to expand our knowledge, equipment size and volume, while adding complementary technologies to our product line, and maintaining contract welding services for industries with variable or low volume needs.

Friction welding produces forged quality joints, with a 100% butt joint weld through the contact area. This solid section shows the narrow heat-affected weld zone and resulting displaced material (flash).



Transition joint for cryogenic application. Inconel to aluminum.



Advantages of MTI's Welding Process

Top Ten Reasons to Consider Friction Welding

1. Dissimilar metals are joined, even some considered incompatible or unweldable.
2. The process is at least twice—and up to 100 times—as fast as other welding techniques.
3. Friction welders are versatile enough to join a wide range of part shapes, materials and sizes.
4. Joint preparation isn't critical... machined, saw cut, and even sheared surfaces are weldable.
5. Resulting joints are of forged quality, with a 100% butt joint weld through the contact area.
6. The machine-controlled process eliminates human error, and weld quality is independent of operator skill.
7. It's ecologically clean—no objectionable smoke, fumes, or gases are generated that need to be exhausted.
8. No consumables are required—no flux, filler material, or shielding gases.
9. Power requirements are as low as 20% of that required of conventional welding processes.
10. Since there is no melting, no solidification defects occur, e.g. gas porosity, segregation or slag inclusions.



Metal combinations not normally considered "weldable," such as these copper to aluminum electrical connectors, can be joined in friction welding.



Automated 60B Inertia Friction Welder (shown below with guarding removed) used to weld automotive air conditioning components (left).



Inertia Friction Welding

Inertia Friction Welding is a variation of friction welding in which the energy required to make the weld is supplied primarily by the stored rotational kinetic energy of the welding machine.

In Inertia Welding, one of the workpieces is connected to a flywheel and the other is restrained from rotating. The flywheel is accelerated to a predetermined rotational speed, storing the required energy. The drive motor is disengaged and workpieces are forced together by the friction welding force. This causes the faying surfaces to rub together under pressure. The kinetic energy stored in the rotating flywheel is dissipated as heat through friction at the weld interface as the flywheel speed decreases. An increase in friction welding force may be applied (forge force) before rotation stops. The forge force is maintained for a predetermined time after rotation ceases. The relationship between the Inertia Friction Welding parameter characteristics appears in the diagram.



Induced failure showing helical flow on an Inertia Friction Weld.



Advantages

Inertia Friction Welding has several advantages over the Direct Drive Friction Welding process:

- Narrower heat affected zones.
- Shorter weld times.
- Helical flow lines and hot working at end of weld cycle can help in weld strength.
- Ease of monitoring, given only two variables for welding: energy (RPM) and pressure. Energy can be monitored before signal is given to weld reducing the variables during welding to one.
- Pre-calculable parameters for most materials and geometry. The process can, therefore, be mathematically scaled (i.e. small samples can be used for large parts development).
- No clutches, no brakes.
- Weld torque is measured indirectly by measuring the rate of spindle speed change.
- Meets Military Standard 1252 and welding specifications of numerous large corporations in the U.S.A.
- Largest Inertia Friction Welder has 2250 ton forge force.

The relationship of inertia friction welding parameter characteristics.

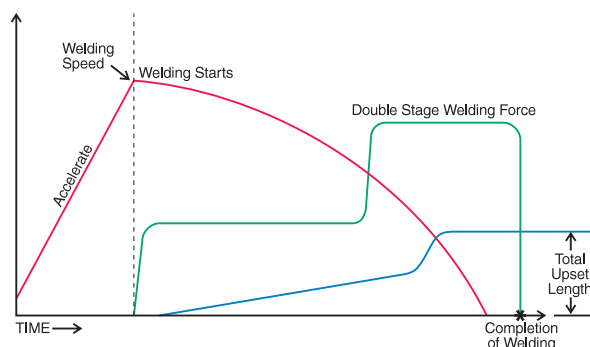
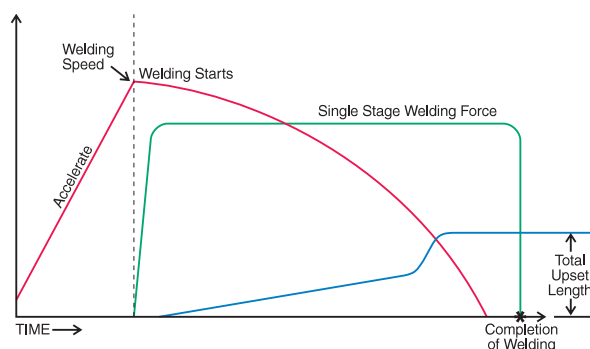

Direct Drive & Hybrid Friction Welding

Direct Drive Friction Welding is a variation of friction welding in which the energy required to make the weld is supplied by the welding machine through a direct motor connection for a preset period of the welding cycle.

In Direct Drive Friction Welding, one of the workpieces is attached to a motor-driven unit while the other is restrained from rotation. The motor-driven workpiece is rotated at a predetermined constant speed. The workpieces to be welded are forced together and then a friction welding force is applied. Heat is generated as the faying surfaces (weld interfaces) rub together. This continues for a predetermined time, or until a preset amount of axial shortening (upset) takes place. The rotational driving force is discontinued and the rotating workpiece is stopped by the application of a braking force or by the weld itself (Inertia Welding). The friction welding force is maintained, or increased, for a predetermined time after rotation ceases (forge force). The relationship between the Direct Drive Friction Welding parameter characteristics is shown in the diagram.

MTI's Hybrid Direct Drive Friction Welders use AC or DC variable speed drives that eliminate clutches and brakes. Proportional hydraulic controls guarantee smooth up and down force control. Through manipulation of deceleration times and forge force ramp up time, welds can be made ranging from near Inertia Friction welds to classic Direct Drive Friction welds.



Induced failure showing typical classic Direct Drive Friction Weld flow pattern.



Advantages

The Direct Drive Friction Welding process has several advantages over Inertia Friction Welding:

- Lower weld force for solid parts. Larger parts can be welded on same tonnage machine.
- Lower weld torque if brake is applied at end of weld cycle. Tooling requirements are, therefore, less rigid.
- Lower RPM for solid parts.
- Weld direct to finished length of $\pm .015$ in. ($\pm .38$ mm) or better with parts that have a larger tolerance before welding (i.e. $\pm .050$ in. [± 1.27 mm]).
- Angular orientation after welding of $\pm 1^\circ$ or better is possible between the two pieces.
- No flywheel change between setups.

Weld quality should never be sacrificed to obtain dimensional accuracy or angular orientation.

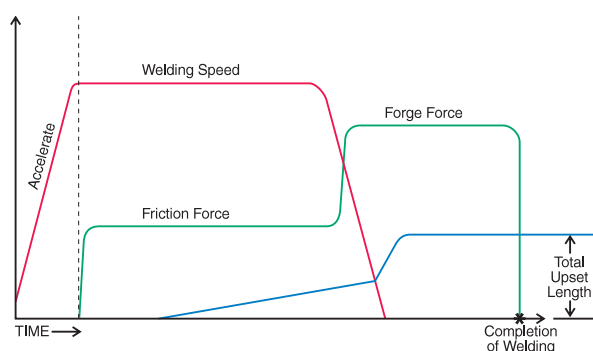

The relationship of direct-drive friction welding parameter characteristics.

Machine Monitors & Controllers

In most industries today, automatic process control and monitoring are an integral part of machine performance. MTI offers a range of weld monitor or controller package configurations designed to meet the specific requirements of each application.

Each of MTI's control packages offer:

- Closed Loop Pressure Control for faster and more accurate pressure response
- Closed Loop Oil Temperature Control for consistent and repeatable pressure control
- Closed Loop Slide Velocity and Position Control for faster and more accurate slide positioning

MTI's standard machine control package features a touch-screen based MMI which serves as the operator pushbutton station, fault and diagnostic message display, quality control monitor, and parameter input screen.

MTI's high performance control package features Windows NT/2000 architecture and proprietary MMI software. Features and advantages include:

- Windows architecture maximizes connectivity to remote networks for data storage and analysis
- User configurable: Reports, Security, Interface Displays, Graphical Displays
- Data Storage: Weld Data files capture a complete record of all weld data and parameters
- Parameter File recreation: all files necessary to recreate a weld can be regenerated from any archived weld data file in case the original parameter files are lost or corrupted.
- Integrated machine diagnostics and messaging to facilitate troubleshooting and cycle setup
- Data Trending: Extensive capabilities to track various aspects of the weld, including offline analysis tools.

Orientation

MTI has the expertise to orient parts using either an Inertia or Direct Drive friction weld cycle. Although the ability to orient parts during a Direct Drive weld cycle has been available for some time, orientation during an Inertia weld cycle is unique. Inertia and Direct Drive friction welding variations each have advantages which make it better suited to a particular application than the other. This advanced orientation technique allows MTI to offer the weld cycle variation and its particular advantages best suited for each application. Additionally, orientation can be achieved on applications with very fast weld cycles, with materials such as aluminum (solid and tubing) and thin wall steel.

Length Control

MTI has developed advanced length control techniques that significantly reduce the variation in upset for both Inertia and Direct Drive friction welds, providing a much tighter control of length loss and final welded part length. These techniques allow the required upset length to be used as a cycle-controlling parameter, and not just a measured outcome of the weld.



Flash Removal

The flash curl generated during welding is coherent, will not flake off, and can often be left intact if design and engineering considerations allow. Alternately, parts can frequently be designed to accommodate the flash curl in a recess (flash trap).

In many cases, if the weld flash must be removed, this can be accomplished on the welder as an integrated part of the machine cycle. Part geometry and accessibility of the flash are the two major factors which determine whether on-machine flash removal can be incorporated, and which system can be employed.

Available systems include:

- Shearing—outside
- Shearing—inside
- Plunge Cut—one axis
- Plunge Cut—two axis

The customer must determine if the increase in machine cycle time and additional complexity of the machine are warranted.

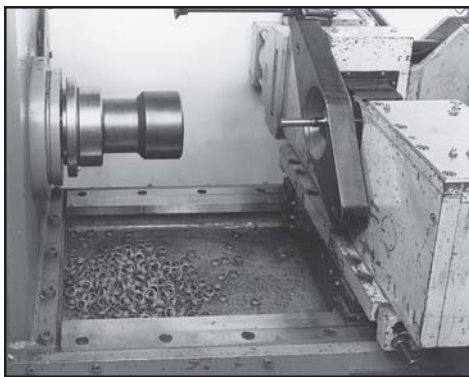

Above left: Model 120 Inertia Welder equipped with O.D. flash shearing.

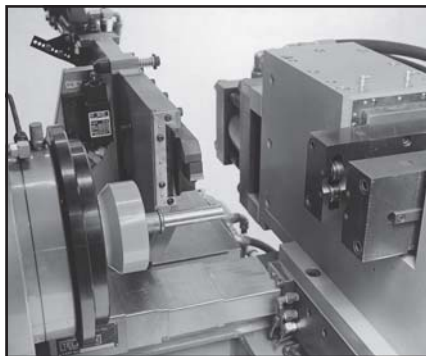

Above right: Model 150B Inertia Welder equipped with plunge-cut flash removal.



Right: Examples of I.D. and O.D. flash removed by shearing.

Safety Features

New machines feature custom-designed guarding with front sliding door for manual loading and unloading of parts, and removable, stationary guards for rear and sides.

Physical interlocks are placed on the sliding door and all removable guarding. Program interlocks protect personnel and the machine by requiring certain conditions to be met before allowing machine movement.

These same safety features can be added to older machines during rebuild or retrofit.

Sound enclosures are available to soften the sound decibels of the motors. They range from an enclosure mounted directly on the hydraulic unit (on smaller machines), to a complete room built around the hydraulic unit on very large machines.

Below: Model 120B Inertia Friction Welder with safety guarding installed.



MTI Welding Services

Research & Development and Contract Job Shop

MTI provides contract welding services for industries with variable or low volume needs. Our in-house job shop offers both research & development, and production services. A wide range of inertia or direct drive friction welders are available to accommodate customer applications.

MTI's knowledge, welding capacity, geographic location and proximity to heat treat sources combine to provide you with the best value for your dollar.

- Machines are available for production runs for material sizes ranging from .250 in. diameter to 6 in. diameter solid, or 43 in.² tubular steel; with weld force ranging from 6-ton to 450-ton.
- Current production lot quantities range from <5 to >300,000 pieces per year.
- Pre- and post-weld processing is available.
- Tooling available for most part configurations. Design capability for both tooling and parts by experienced Design Engineering Department.
- Weld development, feasibility studies and metallurgical evaluation of weld quality performed by experienced Metallurgist.
- Computer storage of parameter data is available for critical applications.



MTI Contract Job Shop.



Model 400S Inertia Friction Welder

This 450 ton welder is the largest contract services welder used in the U.S. Typical applications welded on this 400S include large tubular steel parts, such as diesel engine pistons and aircraft components.

Weldable Combinations in Friction Welding

Since dissimilar metals can often be joined, a significant cost savings can be realized by designing bimetallic parts that use a minimum of expensive metals only where needed. Expensive forgings and castings can sometimes be replaced with less expensive forgings welded to bar stock, tubes, and plates, or with components created solely by welding together bar stock, tubes, and plates.

	Zirconium Alloys	Valve Materials (Automotive)	Vanadium	Uranium	Tungsten Carbide Cemented	Tungsten	Titanium Alloys	Titanium	Thorium	Tantalum	Steel – Tool	Steel – Stainless	Steel – Sintered	Steel – Maraging	Steel – Free Machining	Steel – Carbon	Steel – Alloys	Silver Alloys	Silver	Niobium Alloys	Niobium	Nimonic	Nickel Alloys	Nickel	Monel	Molybdenum	Magnesium Alloys	Magnesium	Lead	Iron Sintered	Copper Nickel	Copper	Columbium	Cobalt	Ceramic	Cast Iron	Carbides Cemented	Bronze	Brass	Aluminum Alloys	Aluminum						
Aluminum																																															
Aluminum Alloys																																															
Brass																																															
Bronze																																															
Carbides Cemented																																															
Cast Iron																																															
Ceramic																																															
Cobalt																																															
Columbium																																															
Copper																																															
Copper Nickel																																															
Iron Sintered																																															
Lead																																															
Magnesium																																															
Magnesium Alloys																																															
Molybdenum																																															
Monel																																															
Nickel																																															
Nickel Alloys																																															
Nimonic																																															
Niobium																																															
Niobium Alloys																																															
Silver																																															
Silver Alloys																																															
Steel – Alloys																																															
Steel – Carbon																																															
Steel – Free Machining																																															
Steel – Maraging																																															
Steel – Sintered																																															
Steel – Stainless																																															
Steel – Tool																																															
Tantalum																																															
Thorium																																															
Titanium																																															
Titanium Alloys																																															
Tungsten																																															
Tungsten Carbide Cemented																																															
Uranium																																															
Vanadium																																															
Valve Materials (Automotive)																																															
Zirconium Alloys																																															



Track roller carrier bracket. Welded structural shapes replace steel casting. Cost reduced by 25%, fatigue strength improved 7 1/2 times.



Aircraft/ Aerospace

The demand for larger aircraft means that aero-engines are growing in thrust, temperature, and size. To withstand the higher temperatures, critical aircraft and aerospace components are being made with materials such as superalloy, bimetallic, stainless steel and aluminum. These materials, which can be difficult and many times impossible to weld with conventional methods, can be joined with the friction welding process. These higher-temperature materials, along with the large component size, require large amounts of weld energy and load. In order to meet this increasing demand, MTI designed a 2,000 ton inertia friction welder. This is the largest friction welder made today. In addition to these large machines, friction welders of all sizes are used in this industry. Aircraft/aerospace components friction welded include compressor rotors, fan shafts, cluster gears, landing gear components, bimetallic rivets and hook bolts, aluminum heat pipes, and cryogenic rocket components. A special machine was designed and built to weld injector posts in the U.S. space shuttle main engines.

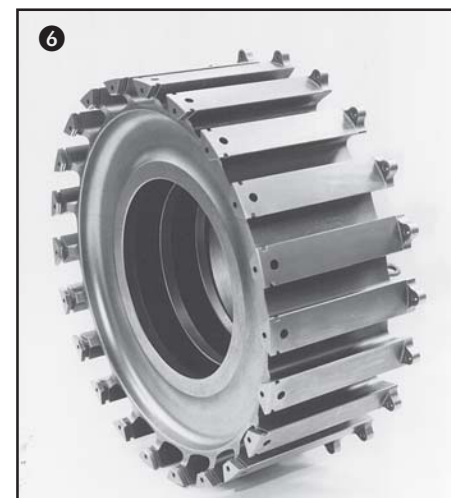
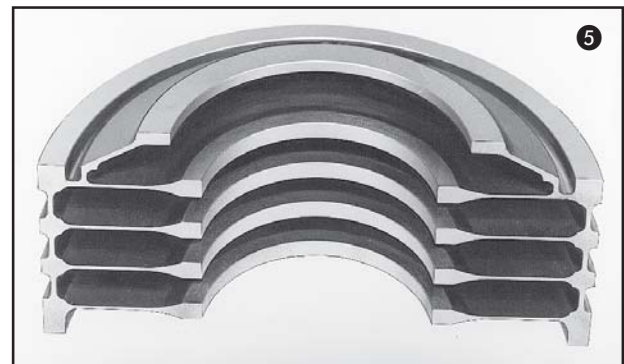
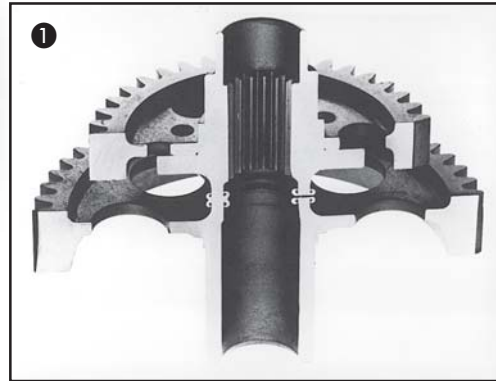

- 1 Cluster gear cross section.
- 2 Cluster gear.
- 3 Inconel 718 tube to rotor assembly.
- 4 Low compression titanium rotor assembly.
- 5 Jet engine compressor rotor—as welded.
- 6 Fan blade rotor.



7

7 Landing gear drag brace.

8 Landing gear component.

9 Forged 300M clevis welded to 300M tubing for manufacture of ball screw. Actuates swing wing on F-14 Fighter.

10 Jet engine component—as machined.

11 Extension welded to four-blade propeller hub forging.

12 Bosses welded to accumulator housing – AISI4340.

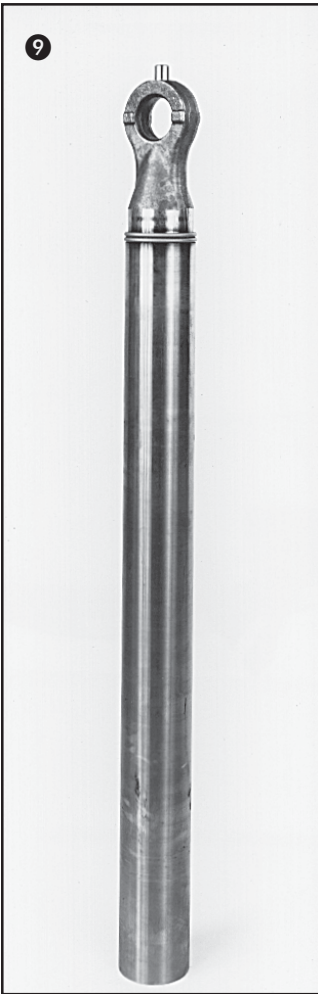

9



8



10

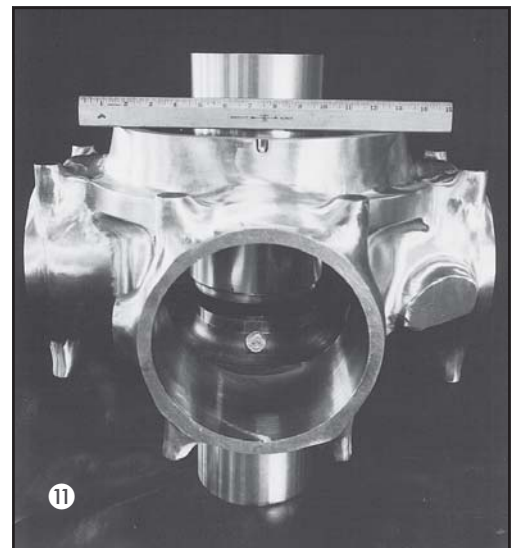

11



12



- A Military jet engine compensating shaft—as welded.
- B Fan shaft for military jet engine-Inconel.
- C Commercial jet engine fan shaft—as welded.
- D Military jet engine fan shaft, cross-section—as machined.



5 Left: Stator vane root weld-as machined. Center: with flash removed. Right: Stator vane root weld (titanium)-as welded.

6 Ball screw actuator-alloy steel.

7 Bimetallic aircraft rivets-titanium.

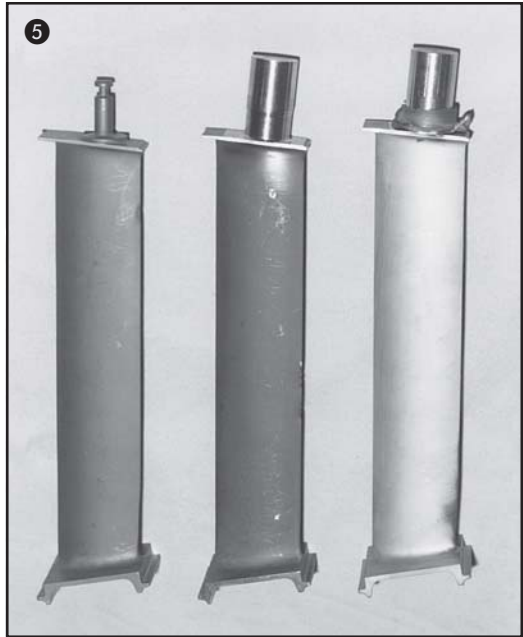

8 Stator vane adjustor lever-titanium.

9 Aircraft hook bolts-superalloy.

10 Lightweight piston for aircraft pump-17-4PH.

11 Aluminum heat pipe for aerospace.

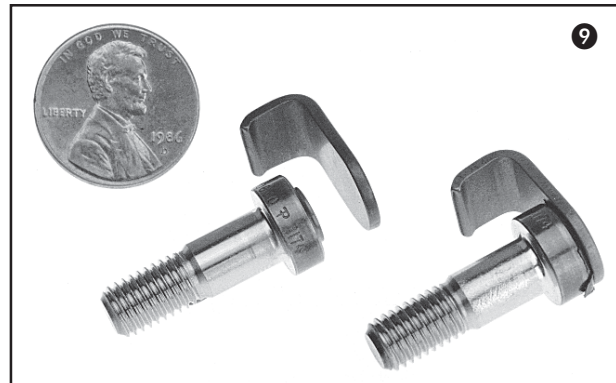
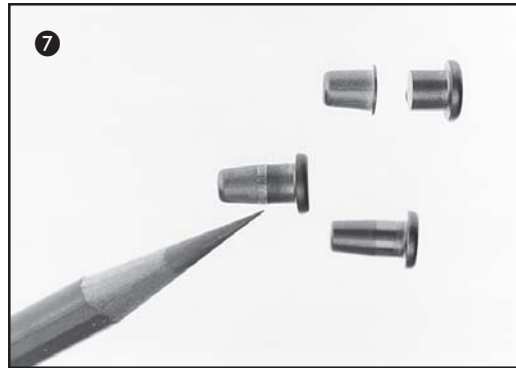



Oil Field Pieces

Weld integrity is a must in the oil field drilling industry. Proven reliability of friction welded connections, coupled with the process advantages such as being clean, fast, consistent, and free of operator-induced error, makes friction welding one of the leading methods of joining flanges to valve bodies, drill pipe, high-pressure hose couplings, and manifold tubes.

A typical string of drill pipe can be three to four miles long, composed of 30-foot sections. The friction welds support the lower drill stem assembly (made up of other drill pipes, drill collars and the drilling bit) and transmit the rotary torque needed for drilling. Friction welding produces a metallurgical bond strong enough to take the high torque and highly loaded rotary tension due to directional drilling.

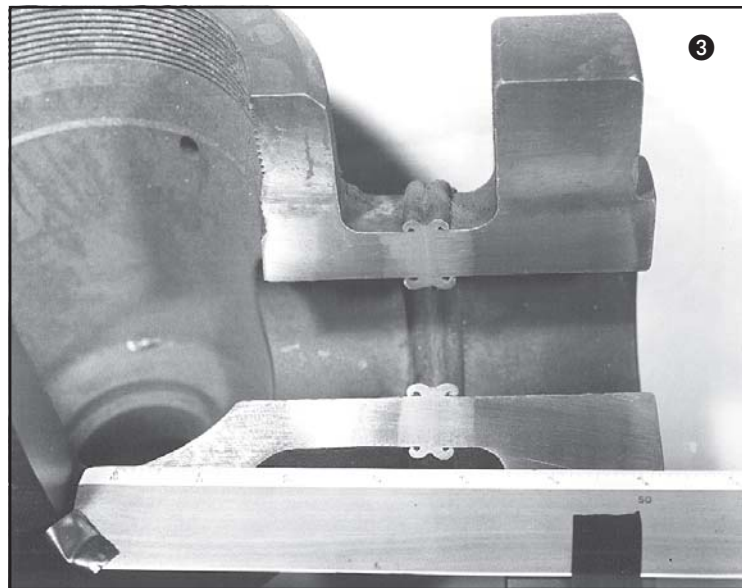
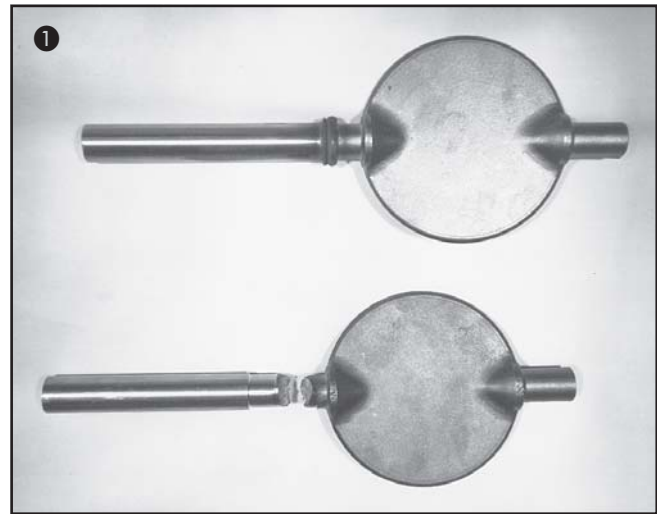

- 1 Butterfly valves. Wrought stainless steel extension welded to investment cast stainless steel butterfly valve.
- 2 High-pressure valve body. Forged flanges welded to forged valve body.
- 3 Cross-section of high-pressure valve body weld.

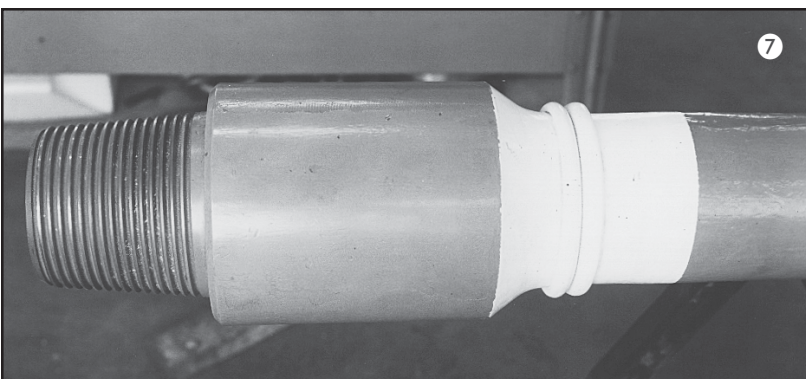
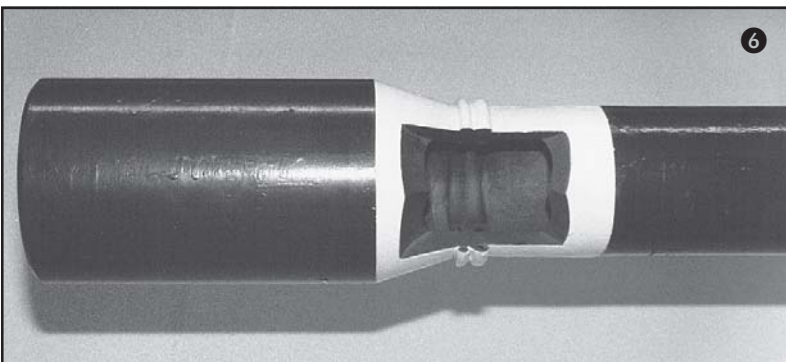
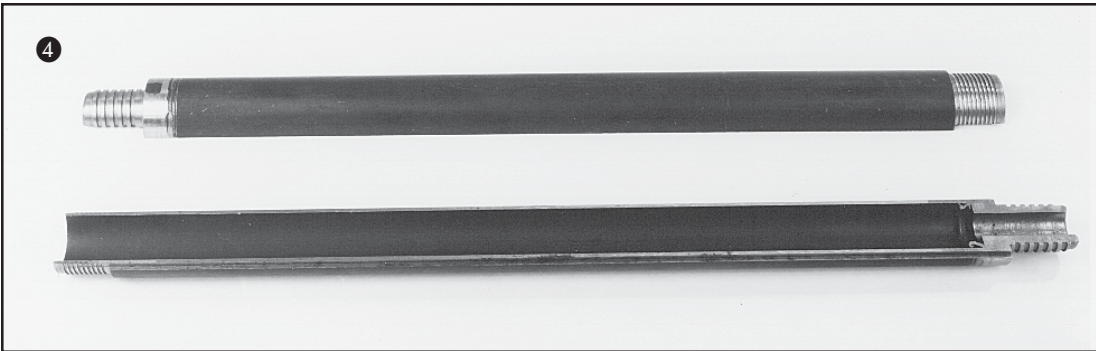

- 4 Geological core drill. SAE4140 end blank welded to SAE4140 tubing.
- 5 Sucker rod. Threaded end connector to forged sucker rod.
- 6 Oil well drill pipe. Close-up of tooljoint to drill pipe weld. Female end.
- 7 Oil well drill pipe. Close-up of tooljoint to drill pipe weld. Male end.
- 8 Cross-section of Inertia Welded manifold tubing used on oil well heads.

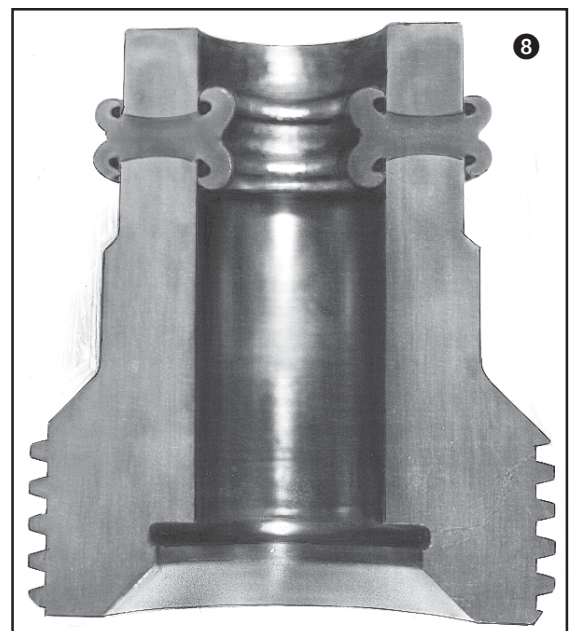



Military

Government agencies in the United States and abroad rely on MTI as their friction welding technology source. MTI's continued research into the stored energy approach to friction welding, first pioneered by Caterpillar Tractor, Inc. and AMF, resulted in the first military standards written around the inertia welding process (MIL-STD-1252).

The advantages of this process such as no smoke, fumes or gases, or few sparks produced, and the fact that the process is machine-controlled, make it suitable for use in potentially explosive or hazardous environments. The machine can be fully automated so the operator can be safely located out of harm's way. MTI's machines and contract welding services have been used in military defense, aircraft, aerospace and ground transportation components.



1



3



2



4

- 1 Formed cap welded to tubing for manufacture of bomblet.
- 2 Fuze liner.
- 3 Fuze liners. Drawn thin-wall tubing to heavy-wall tubing rings.
- 4 Experimental machine gun barrel liner.
- 5 Closure for smoke mortar fill hole, aluminum.



5

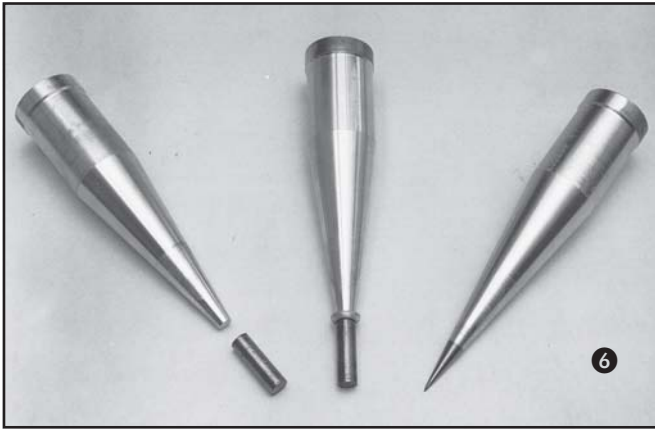

- 6 Experimental windcreens to projectiles.
- 7 Torque tubes for amphibious personnel carrier drive shaft.
- 8 Front bomb case assembly. 18 in. (457mm) O.D.
- 9 Midcase bomb assembly. 18 in. (457mm) O.D., 43 in.² (27,740mm²) of weld area.



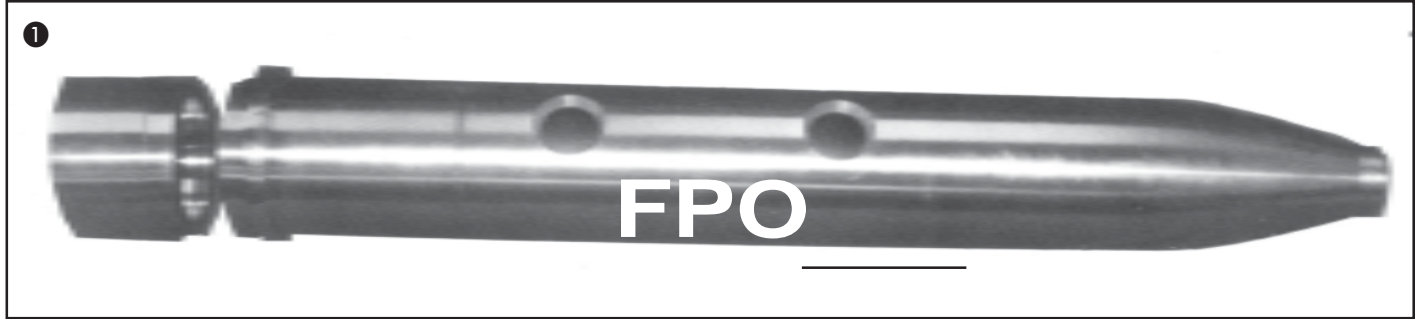

- ① High-explosive bomb development sample.
- ② Mortar round.
- ③ Copper alloy band to 30 mm steel body.
- ④ Adjusting link for tracked vehicle. AISI4140.



- 5 Impact wrench extensions.
- 6 Copper alloy rotating band radially welded to 155 mm alloy steel projectile body and cross-section.
- 7 Experimental aluminum smoke mortar.

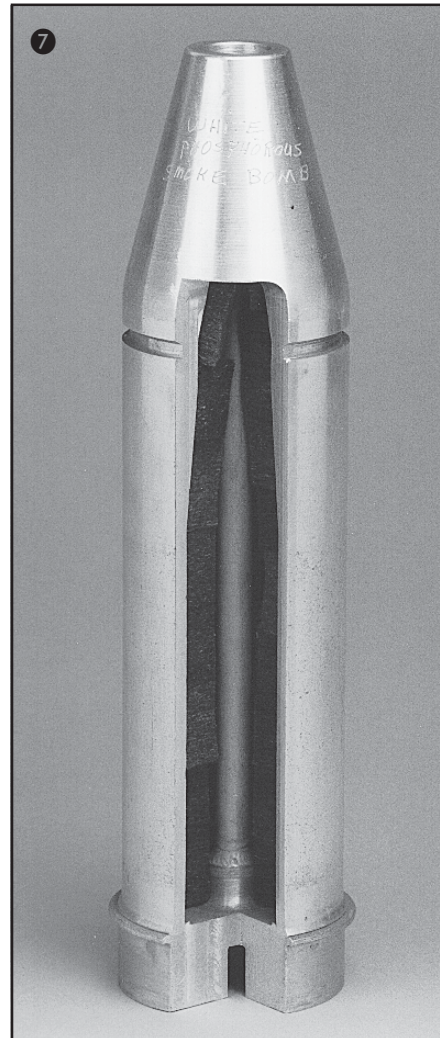



Bimetallic & Special Applications

Metal combinations not normally considered compatible are joined by friction welding, such as aluminum to steel, copper to aluminum, titanium to copper, and nickel alloys to steel. Since dissimilar materials can be joined, a significant cost savings is possible by designing bimetallic parts that use expensive materials only where needed. Engine valve heads made from a nickel-chrome alloy for heat resistance can be welded to an alloy steel stem for wear resistance. A carbon steel shaft welded to a stainless steel stub provides corrosion resistance in pump motors.

MTI has experience with many bimetallic applications. Some others include: copper to aluminum electrical connectors, aluminum to stainless steel copier fuser rollers, titanium to copper electrodes used in seawater desalination cells, and stainless to alloy steel propeller shafts for outboard motors.



- ① Carbon steel/stainless steel marine outboard engine drive shaft
- ② Bimetallic pump motor shaft. Stainless steel stub joined to carbon steel shaft for corrosion resistance.
- ③ Inertia-welded copper-to-aluminum tensile specimen.
- ④ Aluminum and copper electrical connector.





- 5 Examples of various aluminum/copper electrical connectors and a threaded titanium/copper electrode stud.
- 6 Aluminum/stainless copier fuser roller.
- 7 Pin heading done using "interrupted" weld cycle.
- 8 Solid 2219 aluminum/304 stainless steel tube.
- 9 Transition joint for cryogenic application. Inconel to aluminum.

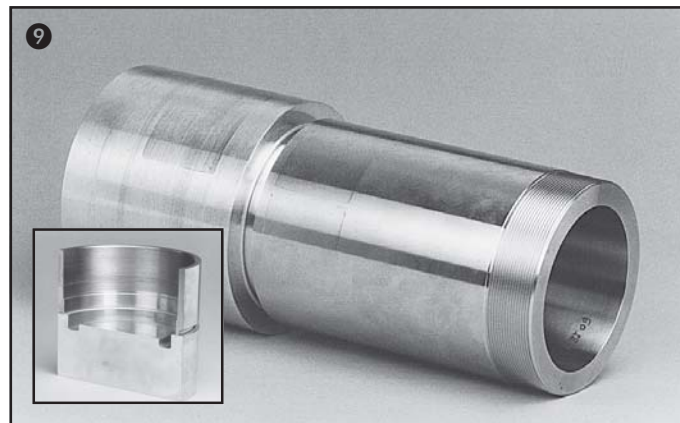
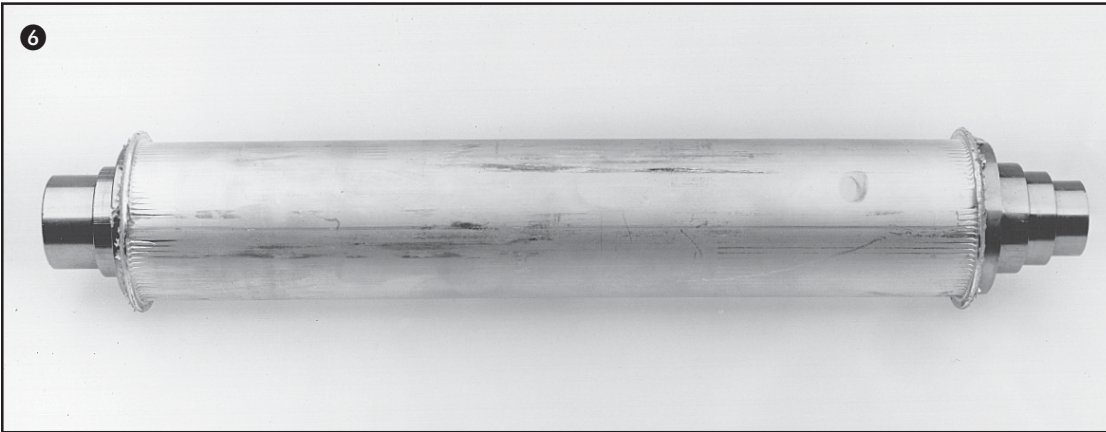



Agricultural & Trucking

Friction welding is used extensively in the agricultural and trucking industries because the welds are of forged quality, with a 100% butt joint weld throughout the contact area. This bond is strong enough to handle the high stress and torque required of heavy machinery components. Component costs can be significantly reduced by replacing expensive, totally-forged parts with forged ends welded to bar or tube stock, without a reduction in quality.

One example of this would be hydraulic piston rods, which have similar-size ends, but vary in rod diameter and length. Instead of stocking expensive forged components in a variety of different diameter and length configurations, standardized ends could be welded to the required-size rod, reducing component costs as well as physical inventory requirements.

Other agricultural and trucking applications include front axle yoke shafts, rear axles, drive shafts, and gears.

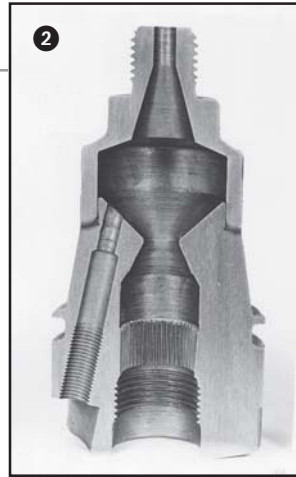

- 1 Water pump gear.
- 2 Cross-section of inertia welded diesel engine precombustion chamber—SAE5120.
- 3 Water pump—as welded.
- 4 Water pump—finished.
- 5 Diesel engine piston.

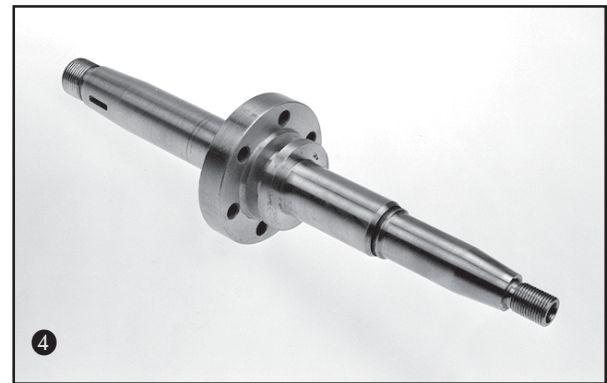

- 6 Track roller. Forged halves welded together to produce track roller assemblies.
- 7 Steel-backed, bronze-laminate thrust washers and sleeves welded together to produce track roller bushings. Replaced costly solid bronze castings.
- 8 4 in. (101.6 mm) diameter bar stock welded to hub forging to produce rear axles for tractors.
- 9 Truck trailer brake S-cam.
- 10 Forged wheel spindles joined to 5 in. (127 mm) diameter, .5 in. (12.7 mm) wall tubing to produce trailer axles.

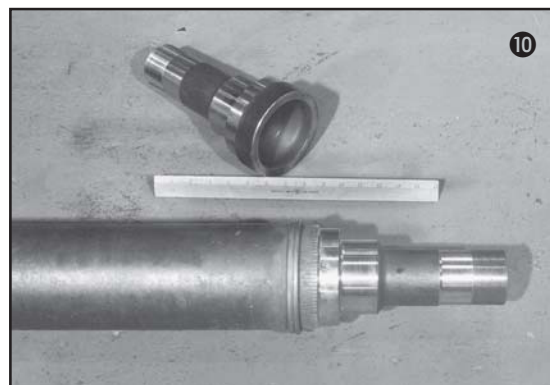
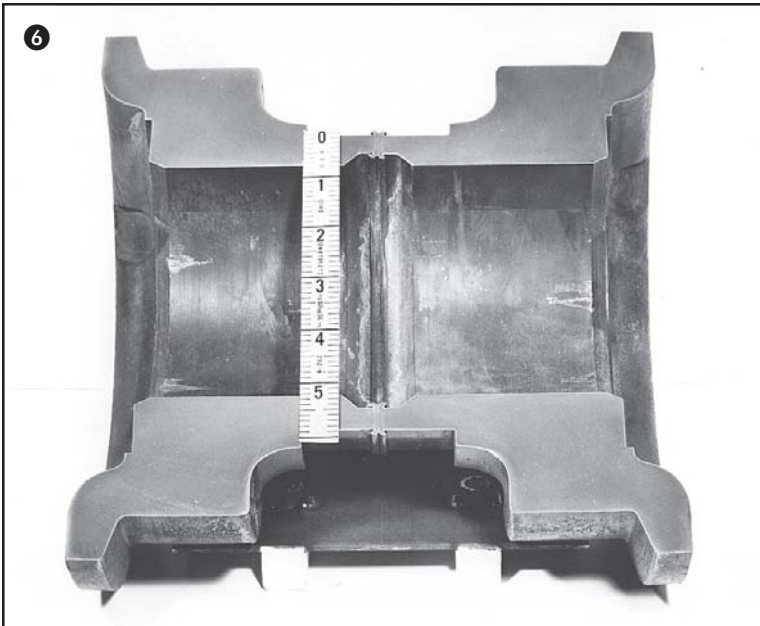

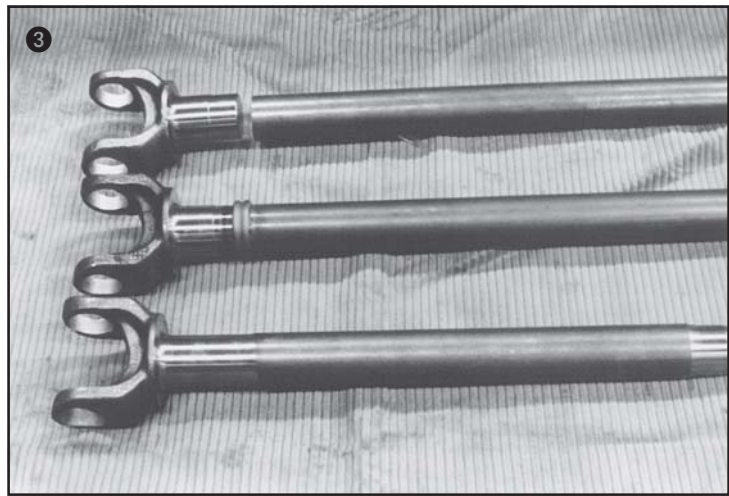
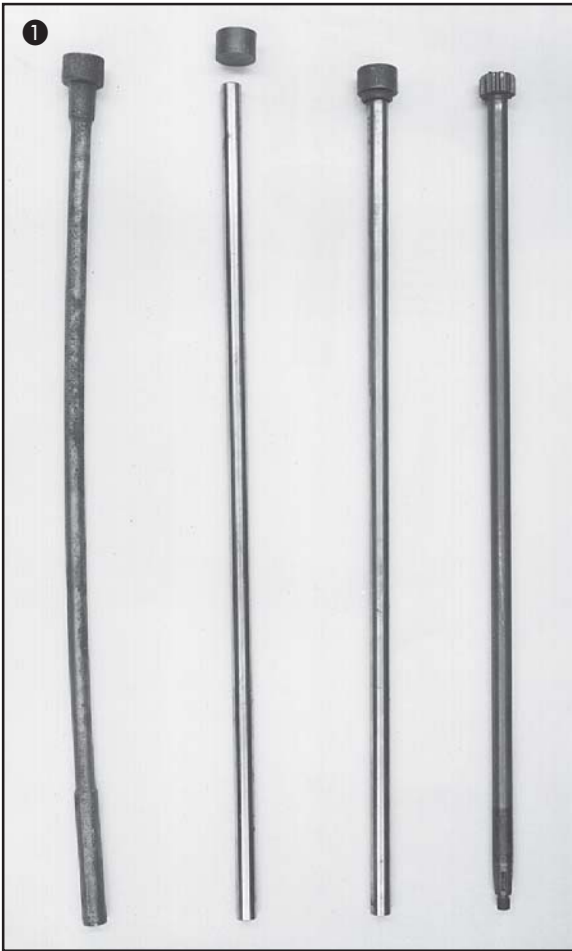

- ① Power control drive shaft for motorgrader. Inertia weldment replaces upset forging (left) which required five straightening operations.
- ② Universal joint clevis.
- ③ Front axle yoke shaft for four-wheel-drive vehicles. SAE1040 bar stock to SAE 1040 yoke forging.
- ④ Pin assembly. Pre-chromed pin welded to retaining plate.





- 5 Finished gear welded to clutch drum.
- 6 Oil pump gears. Welded bar stock replaces forged blanks. 15%–30% cost reduction (depending on size and usage).
- 7 Cluster gear. Small finished gear welded to larger gear blank.
- 8 Two pre-finished transmission gears welded using precision piloted tooling.
- 9 Chain drive sprocket.

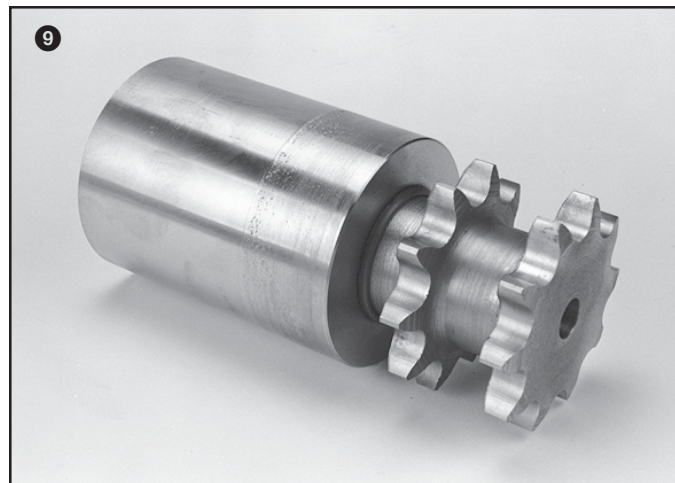
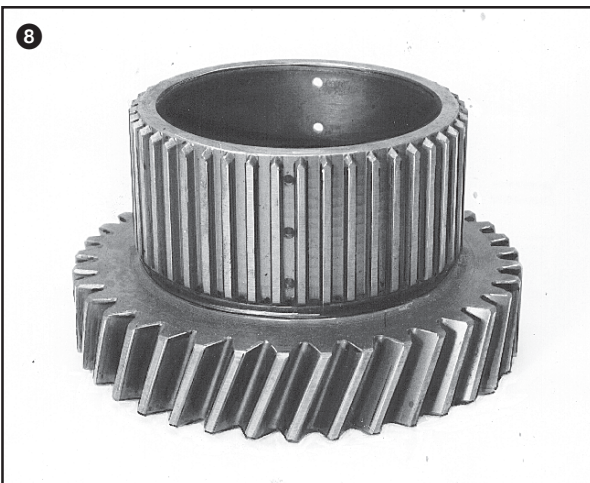
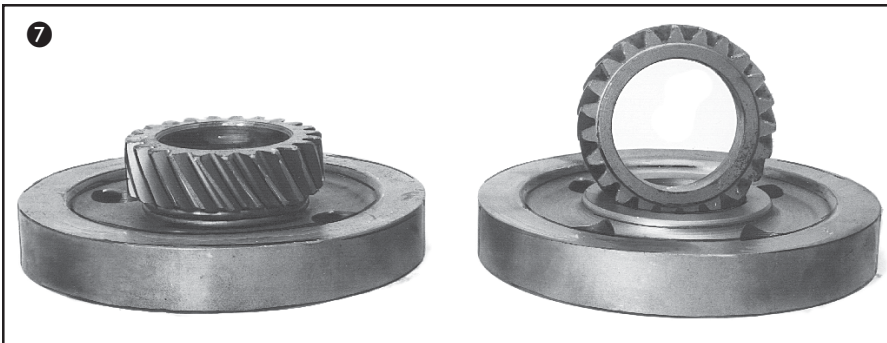
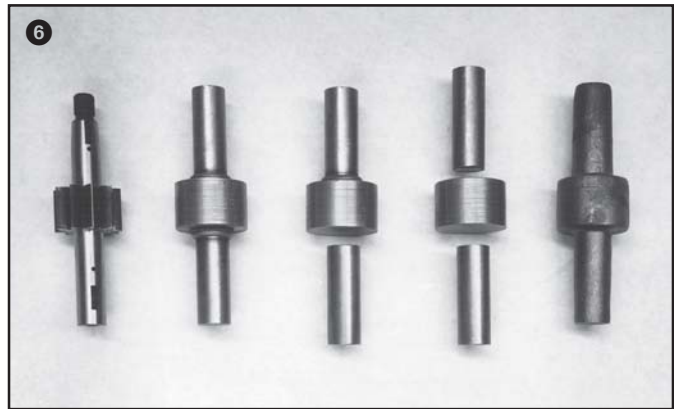

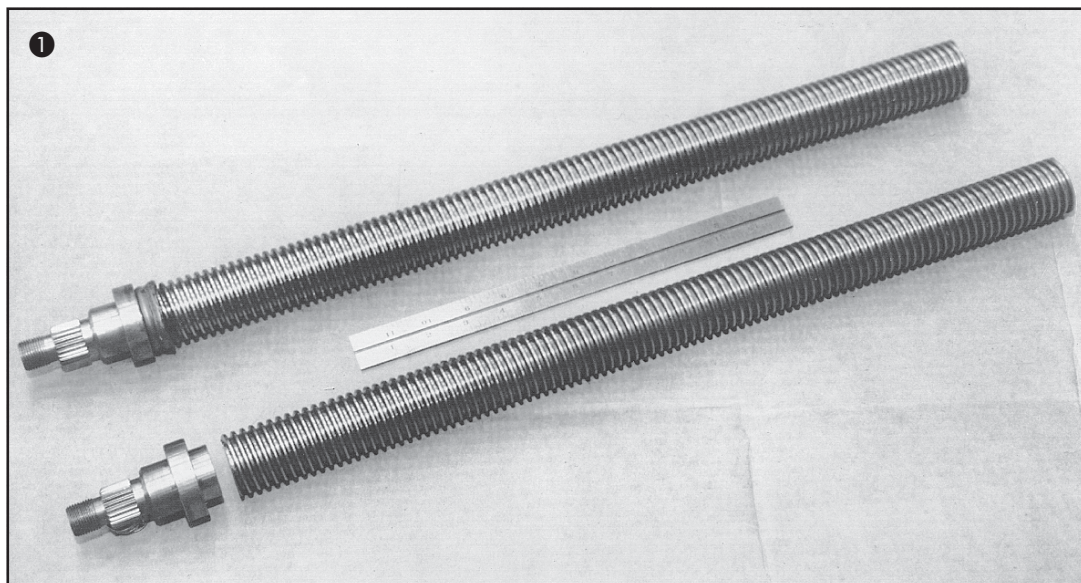

① Lift screw. Roll threaded stock cut to length and welded to screw machined ends.

② Lift link-ball socket. Forged couplings welded to tubing and bar stock.

③ Truck rear suspension link welded on twin 150 Inertia Welder. Ends are oriented to within $\pm 1^\circ$ of each other.

④ Torque rod. Forged eye welded to various bar stock lengths.





- 5 Hydraulic piston rods. Rod eyes cut from heavy-wall tubing welded to pre-chromed bar stock.
- 6 Track adjusting yoke for commercial tracked vehicles.
- 7 Hydraulic piston rod.
- 8 Bar stock welded to clevis forging for manufacture of large (5 in. (127 mm) diameter and larger) piston rods.

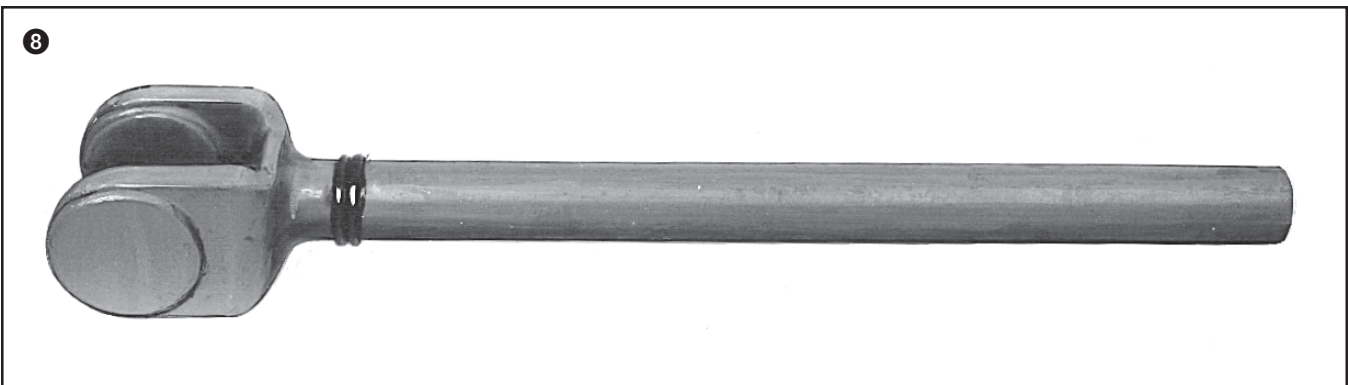
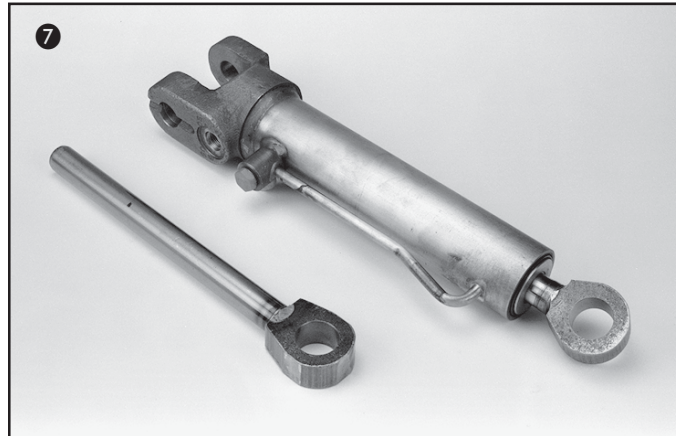



Automotive

In the United States, the automotive industry has played a dramatic role in the volume of friction welding applications and equipment in the '90s and possibly the history of the industry.

Automotive friction welding applications include: stabilizer bars, engine valves, torque converter covers, drive shafts, gear blanks, steering components, water pumps, axles, camshafts, air conditioning accumulators, U-joints, and more.

Demand for automotive airbag inflators has stimulated the increase in the number of friction welders manufactured for the automotive industry since the 1980s. Advantages such as full-penetration weld, as well as its narrow heat-affected zone have made friction welding a key method for joining fully-loaded airbag inflators. Successful material combinations include aluminum, low carbon steel, and stainless steel alloys.

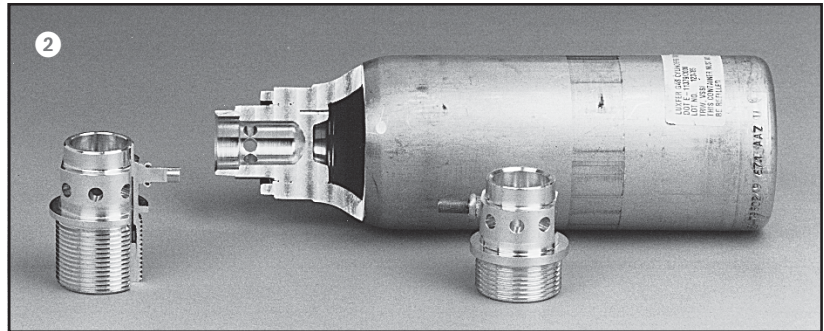
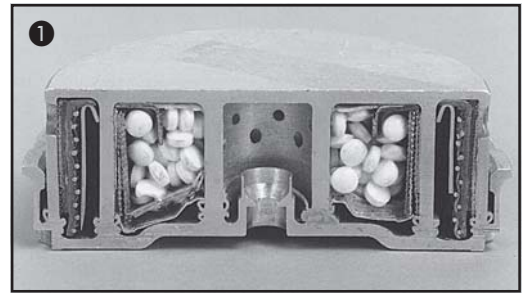

Airbag Inflators

- 1 Driver side airbag inflator—cross-section.
- 2 Passenger side airbag.
- 3 Hybrid passenger side airbag inflator.
- 4 Driver & passenger side airbag inflators.
- 5 Side-impact airbag inflators.
- 6 Passenger side airbag inflator and cross-section (aluminum).





7 Aluminum wheel rim and cross-section.



8 Forgings can be welded to bar stock, tubes, plates and the like, as shown with these drive shafts.

9 Experimental aluminum suspension link.

10 Experimental chassis component.

11 Retainer–differential bearing blank cross-section (left). Bearing housing retainer for transaxle (right).

12 Transmission part.

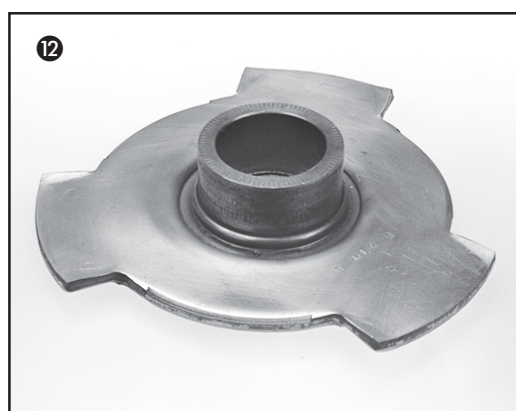
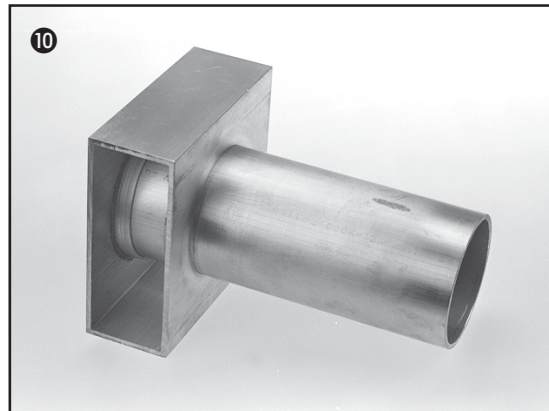
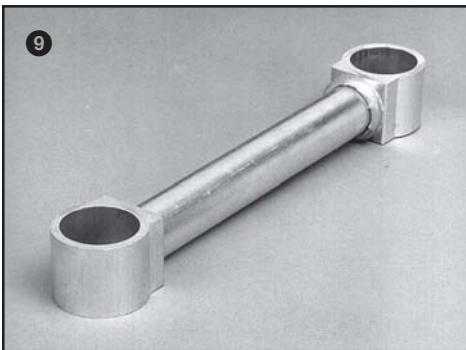



1 Hollow engine valves for lightweight and liquid-cooled applications.

2 Flanged axle.

3 Experimental hollow automotive rear axle. Tubing welded to hub forging and spline blank. Replaces solid forging for weight reduction.

4 Bimetallic engine exhaust valves showing head and stem components, as-welded valve and welded valve with flash removed by shearing.

5 Automatic transmission output shaft. Stamped steel flange welded to bar stock.

6 Fan shaft bracket assembly. Bar stock welded to plate replaces machined forging.

7 Rolled ring gear welded to flywheel stamping produces distortion-free flywheel ring gear.

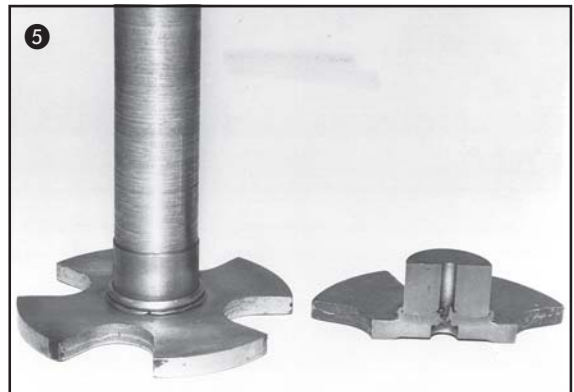

- 8 Alternator bracket. Bar stock welded to plate replaced forging.
- 9 Viscous drive fan shaft couplings. Replace forgings.
- 10 Starter pinion assembly. Sintered steel gear welded to sleeve.
- 11 Automotive hydraulic jack. Fabricated from tubing and plate stock.
- 12 Cross-section of hydraulic jack showing 2 tubular welds which were made simultaneously to the base plate.
- 13 Speed selector shaft. Mild steel yoke welded to SAE1045 shaft replaced pinned assembly.



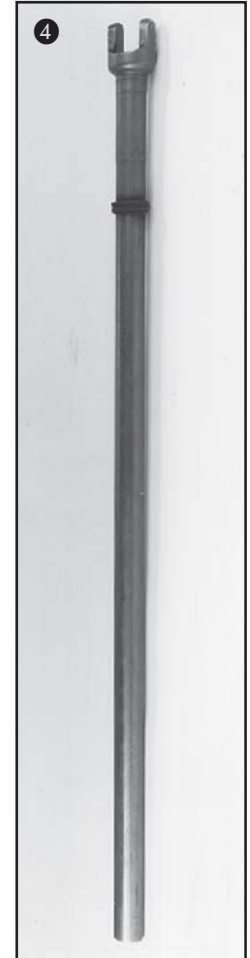
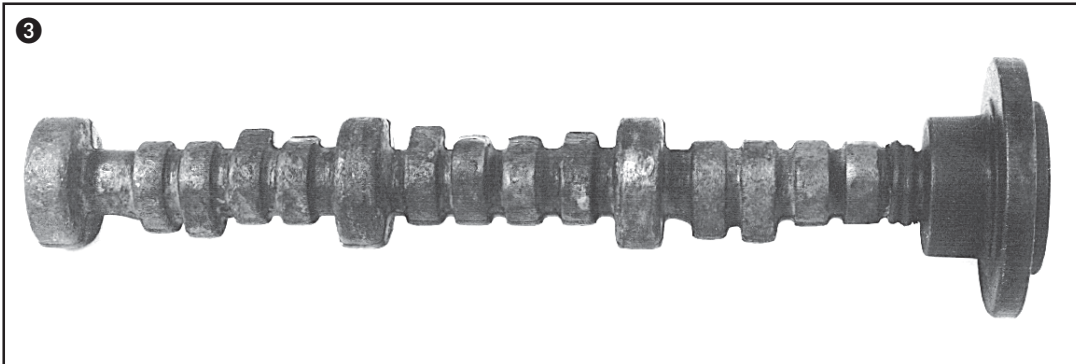
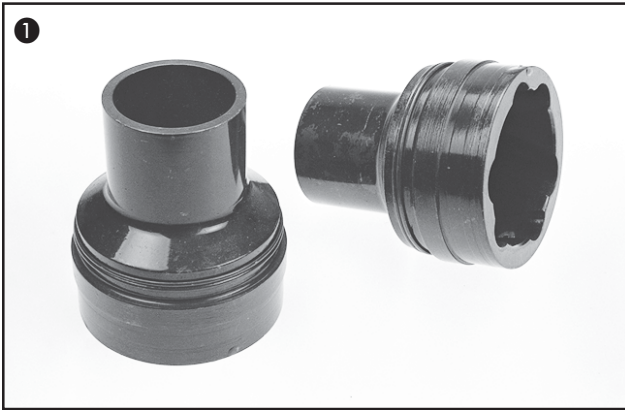

- 1 Constant velocity joint.
- 2 Stem pinion.
- 3 Forged cam shaft blank welded to forged flange.
- 4 Forged yoke welded to bar stock for manufacture of tilt-steering shaft.
- 5 Universal joint assembly with welded extension shaft.
- 6 Steering shaft welded to pre-assembled knuckle.
- 7 Water pump hub and shaft.

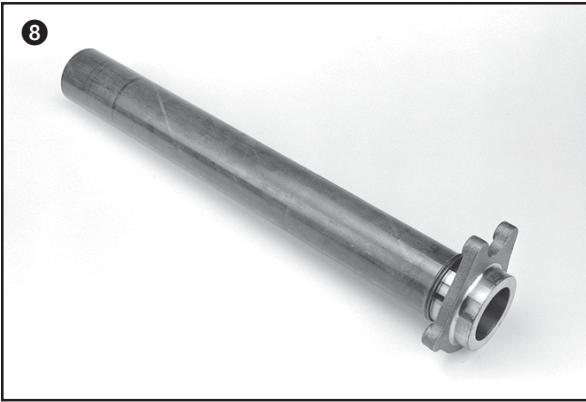

8 Automotive axle tube



9 Rear axle housing tube. Forged tube end welded to tube stock.

10 Automotive transmission component. Machined tubing welded to cold-formed end.

11 Electric motor housing and shaft for automotive cooling fan.

12 Direct clutch drum and hub assembly used in automatic transmissions. Mild steel tubing welded to cold-formed clutch drum. Cross-section.



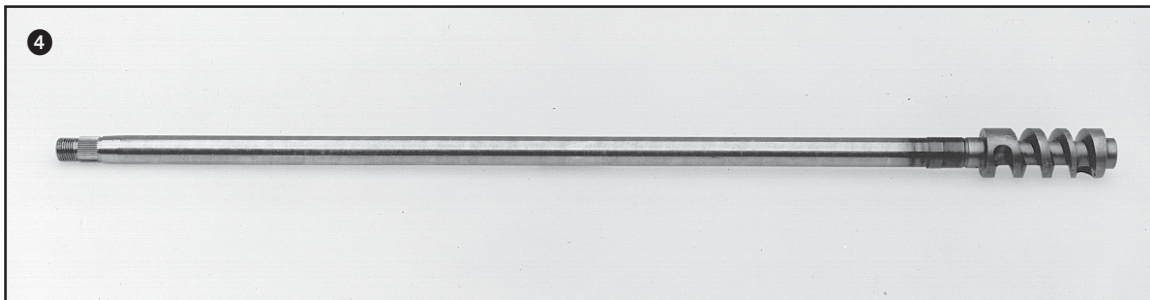
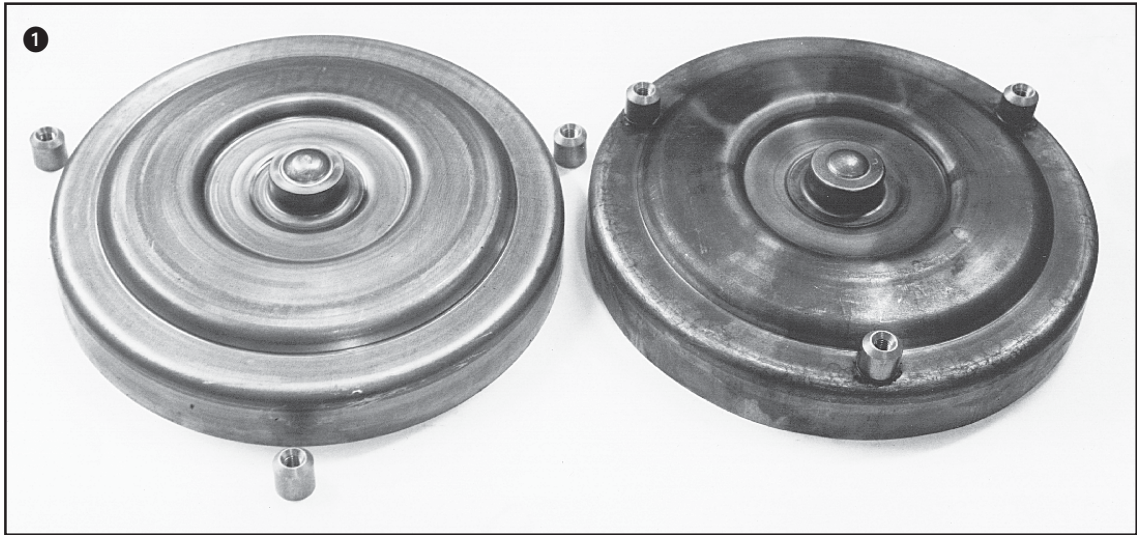

- 1 Torque converter cover. Three mounting nuts welded to cover for mounting of flywheel ring gear.
- 2 Torque converter pump.
- 3 Clevis.
- 4 Worm gear drive shaft.
- 5 Drive shaft.



- 6 Front wheel drive shaft.
- 7 Turbocharger.
- 8 Transmission gear. Finished spiral bevel gear welded to tubular shaft.
- 9 Wheel spindle.
- 10 Air conditioner accumulator. Aluminum housing.
- 11 Transmission input shaft.



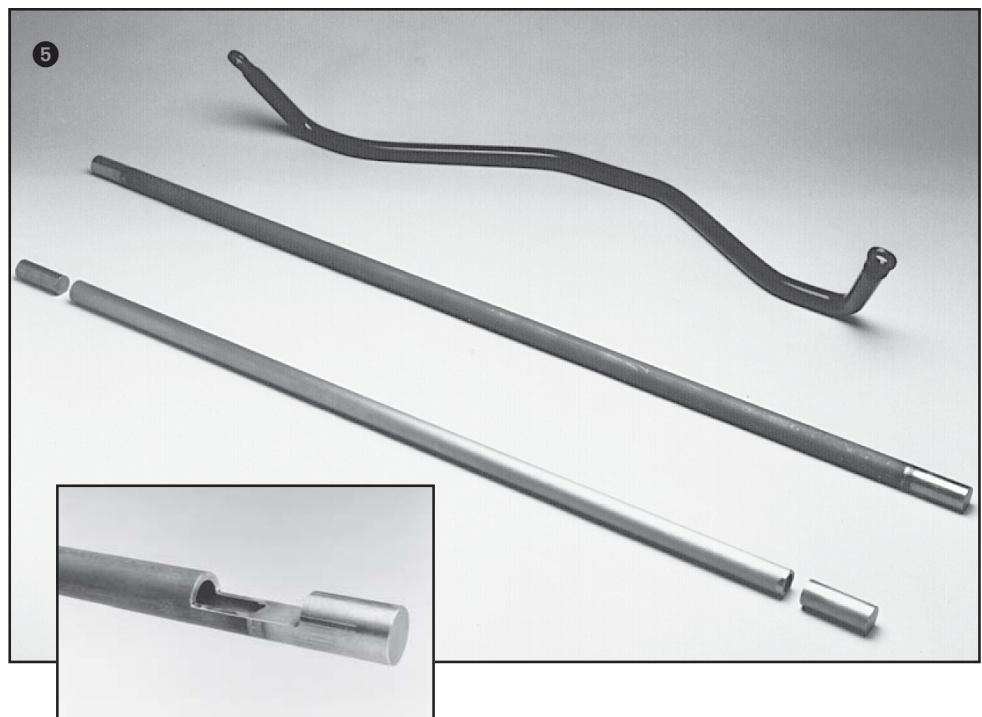
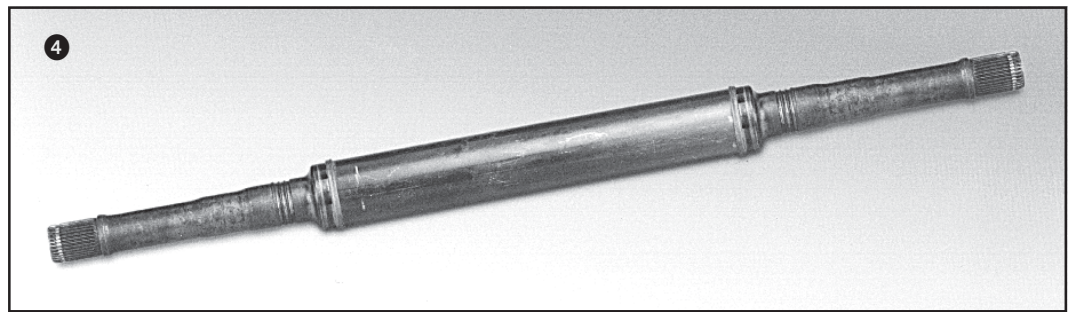

- 1 Brake caliper. Tubing joined to formed caliper.
- 2 Drive extension (internal spline one end).
- 3 Front suspension struts
- 4 Sport utility 4X4 interconnecting shaft.
- 5 Stabilizer bars. Tube welded to solid end. Cross-section.

- 6 Input shaft for automotive transmission. Stamped hub to machined bar stock.
- 7 Shock absorber base cup. Weld between threaded stud and base cup firmly traps washer in place.
- 8 Bumper shocks. Tubing welded to stamping for impact absorbing bumper mounts.
- 9 Air conditioner rotor assembly. Outer rotor pole is welded to inner rotor pole then this assembly is welded to pulley blank.





General

As a rule of thumb, probably all metallic engineering materials which are forgeable, are weldable by the friction welding process.

Generally, the only requirement of the component design, is that one of the pieces to be welded must have a nearly-symmetrical shape around its axis of rotation.

The second part to be joined can be of any shape or form, as long as the weld contact area is a "butt" design. Joint preparation is not critical—machined, saw-cut, and even sheared surfaces are easily welded.

Our continuing development of new prototype applications allows us to remain a leader in the friction welding industry. Contact MTI today to see how friction welding can work for you.

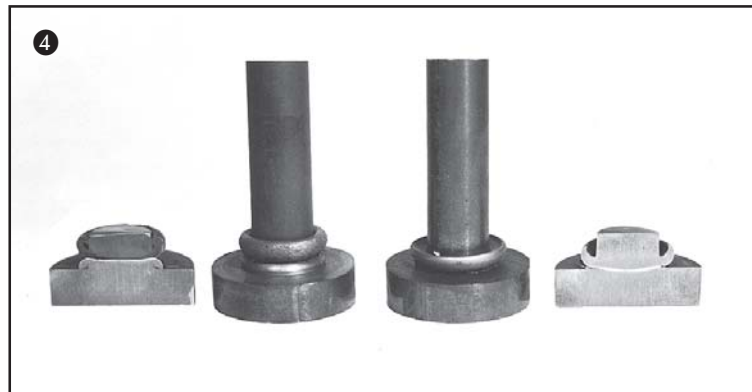
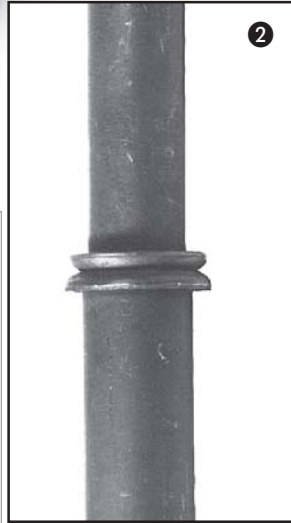

Cutting Tools

- ① Tool steel to carbon steel drill bit.
- ② Twist drill blank. Welded blanks made from M10 tool steel bodies and SAE4140 shanks.
- ③ Countersinks. High-speed steel (M2, M42) heads welded to mild-steel (1020) shanks.
- ④ Keyway and T-slot cutters. Welded blanks made from AISI 6145 shanks and M4 tool steel heads.

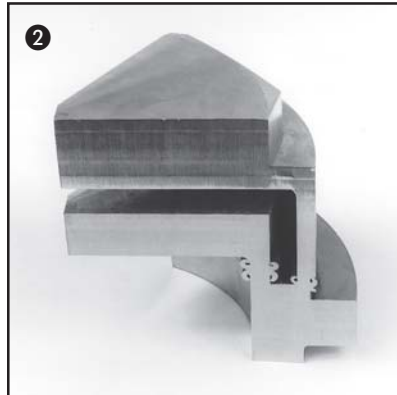

Waste Canisters

- 1 Overpack (2nd safety weld) closure for waste canister–stainless steel.
- 2 Cross-section of primary closure weld and overpack weld.
- 3 Cross-section of primary closure weld.
- 4 Primary closure for waste canister–stainless steel.

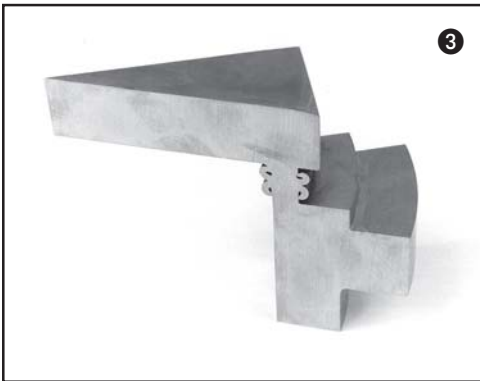

Spindle Blanks

Welded blanks replace costly forgings for machine tool spindles.





- ① Check valve fitting to stamped housing for refrigeration unit.
- ② Medical X-ray target.
- ③ Disc brake for fork lift truck.
- ④ Center screw for automotive jack.
- ⑤ Golf putters.
- ⑥ Axle shaft for lawn & garden tractor.

- 7 .375 in. (9.5 mm) diameter stud welded to backing plate.
- 8 Lift screw assembly. Acme threaded bar welded to clevis block.
- 9 Finished ball and mounting stud.
- 10 Flywheel ring gear for outboard motor. Forged hub welded to stamped and heat-treated ring gear.
- 11 Forged eye welded to bar stock.
- 12 Actuator arm for sewing machines.



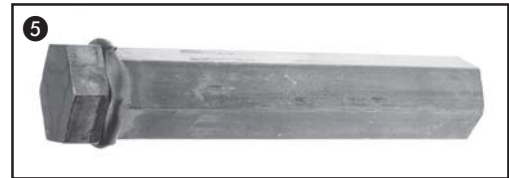

- ① Composite driver blade.
- ② Mining bit.
- ③ Miniature weld application.
- ④ Light weight hydraulic piston.
- ⑤ High voltage contact. Cu-Cr to W-Cu.
- ⑥ Diesel engine cylinder.

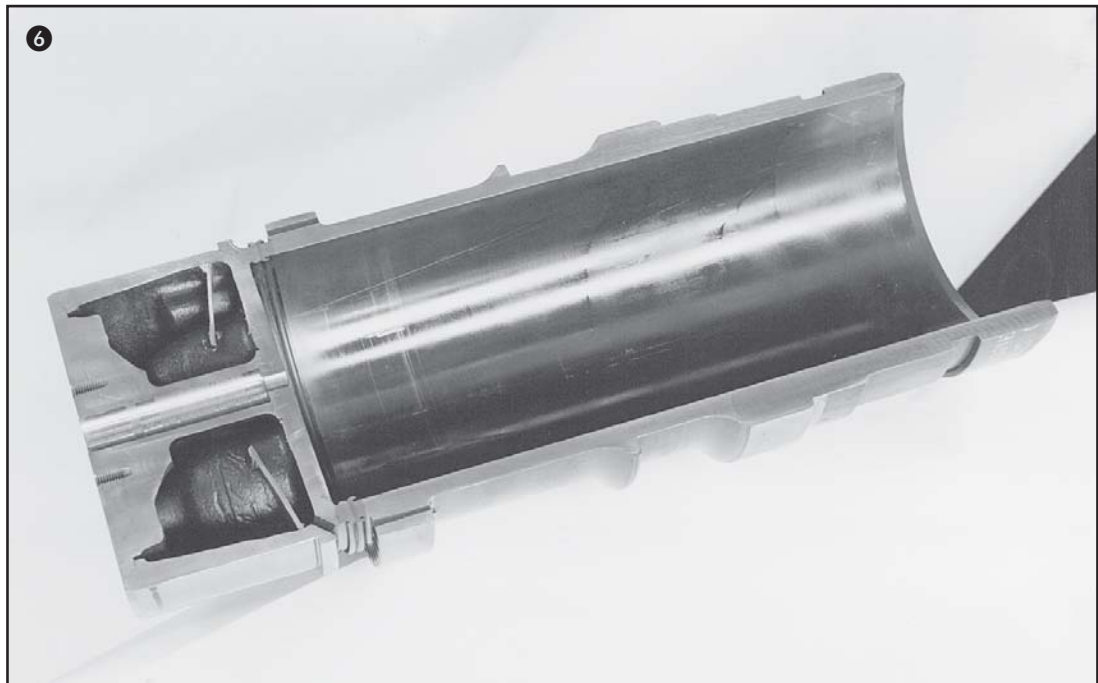

- 7 Shifter yoke and pin assembly for marine transmission. SAE1010 steel pin welded to formed yoke.
- 8 Engine tilt quadrant shaft used in marine stern drive engine. SAE8650 alloy steel bar welded to 410 stainless steel replaced more expensive all-stainless forgings.
- 9 Torque bolt. Head shears off when tightened to the proper torque.
- 10 Eyebolt. Standard forged eyes are welded to various lengths of bar stock.
- 11 High-pressure hydraulic hose coupling. Standard flanges and stubs welded to bent-to-order tubing. Reduced inventory, improved delivery. Lower piece shows result of 21,000 psi (144,790 kPa) pressure test. No weld failure.
- 12 Various hand tools. Forged, cold headed and stintered heads and ends welded to barstock handles and extensions.

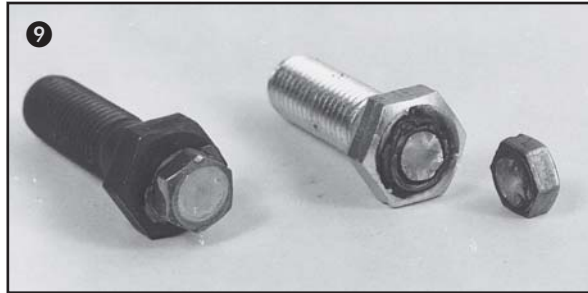

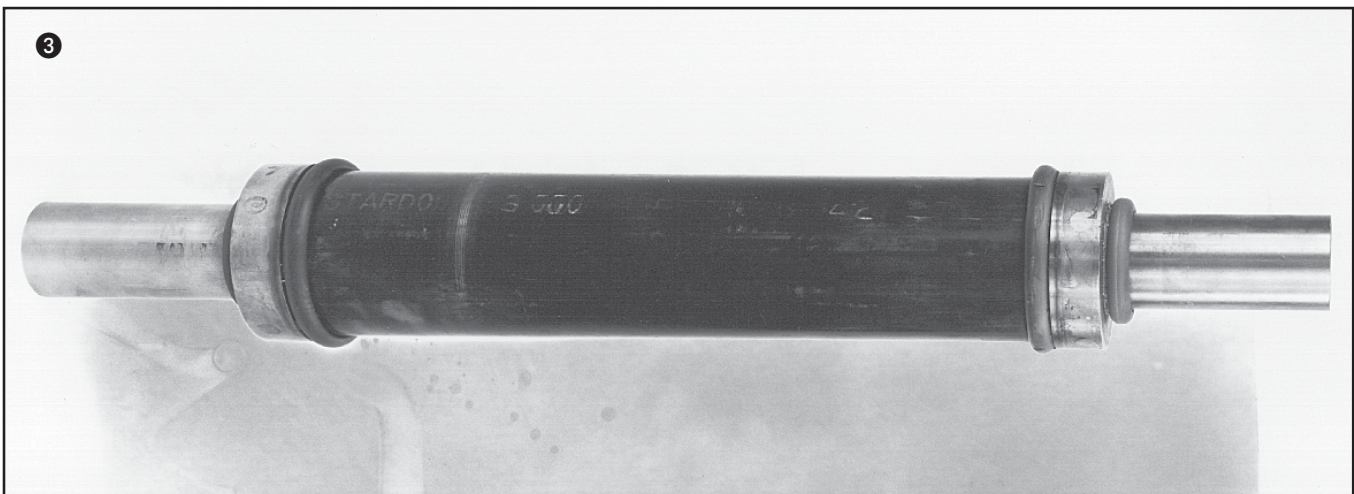
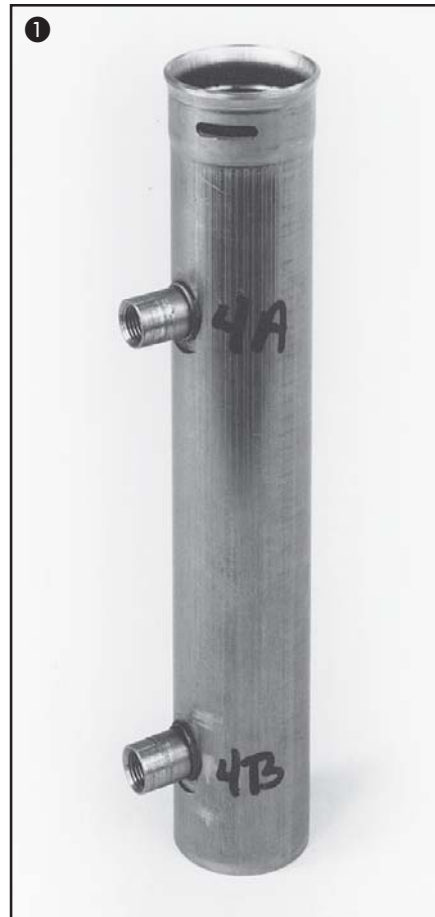

- 1 Ports welded to cylinder body used in automotive steering assembly.
- 2 Fabricated hydraulic cylinder. Tubing welded to end cap. Parts welded to cylinder body—AISI4340.
- 3 Printing press roller. Five-piece welded assembly comprised of tubing, end caps and journals.
- 4 Automotive lug wrench. Bar stock welded to formed socket.

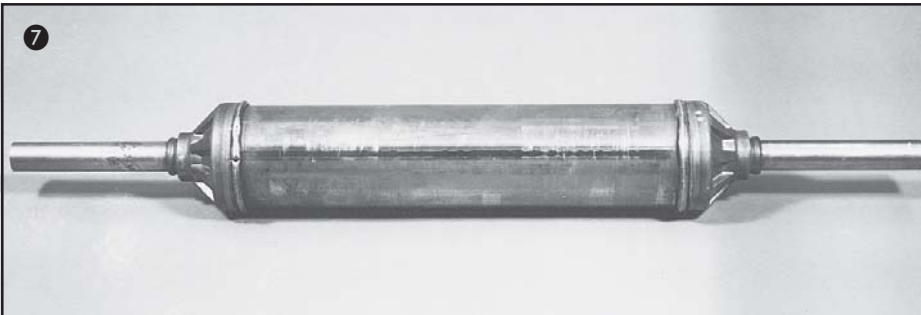
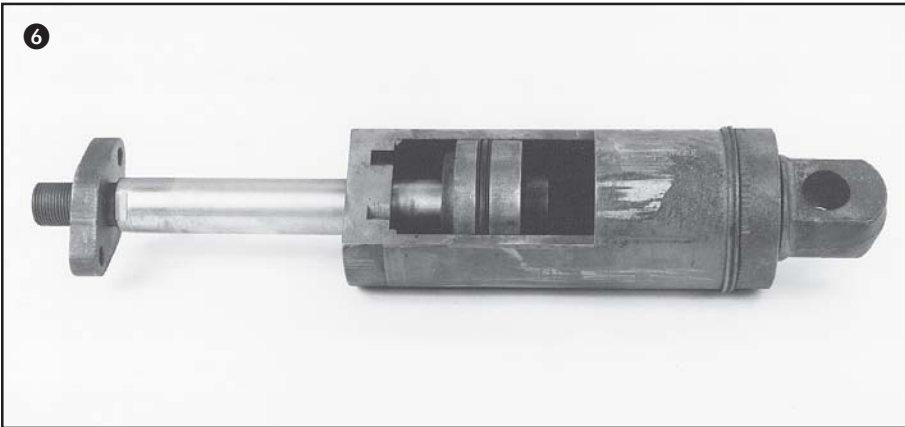
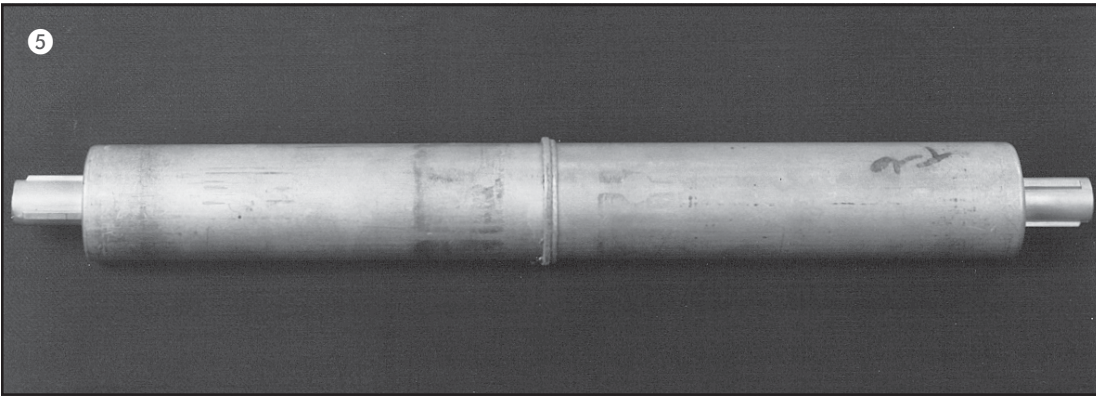

- 5 Aluminum copier roller.
- 6 "Throw away" hydraulic cylinder. Four welds to complete assembly.
- 7 Tubular drive shaft.
- 8 Accumulator.

Special Welders and Automated Machines

Our design engineers and machine tool builders are specialists in the design and building of custom welders and automation equipment. These special welding cells dramatically increase production rates over manual operation, while requiring minimal operating personnel.

Special Model V120 Inertia Friction Welder

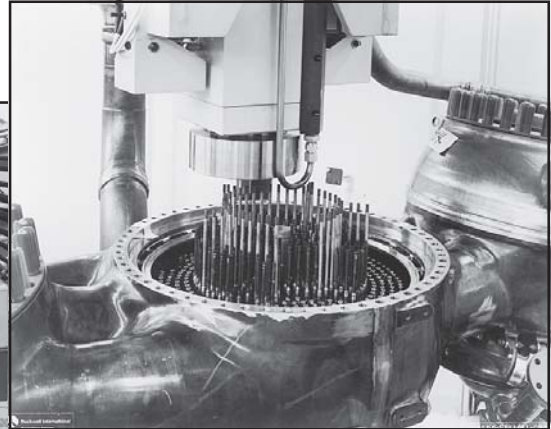
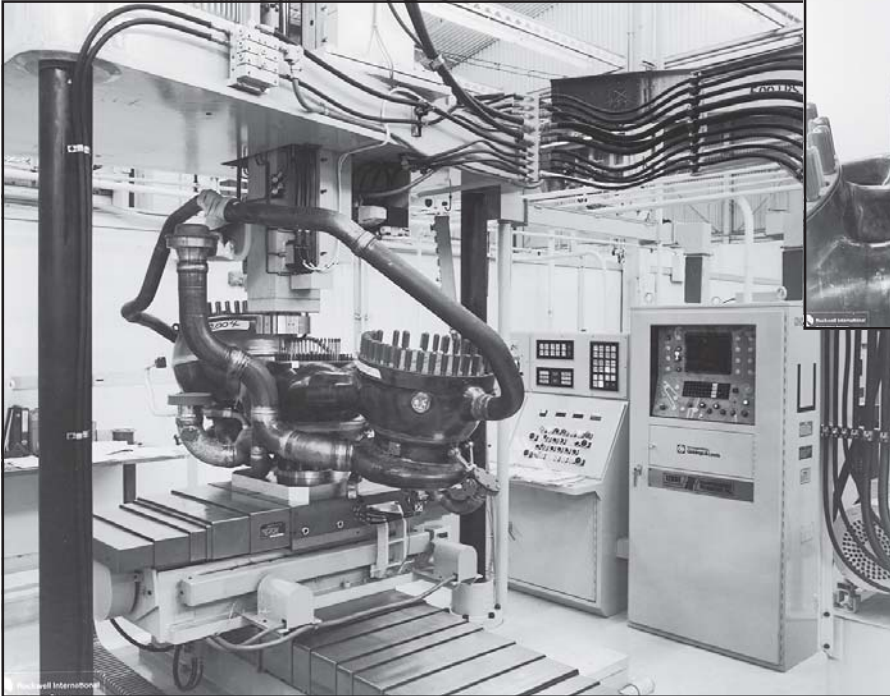

Special vertical 120 Inertia Friction Welder has CNC table to position space shuttle main engines for welding of injector posts. Superalloy injector posts are welded to space shuttle main engine. 600 posts per engine, 3 engines per shuttle.

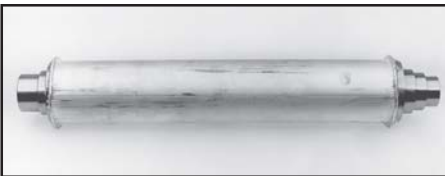

Automated 180BX Inertia Friction Welder

Used for welding copier fuser rollers.

This welding cell includes automated spindle loading, fixture loading and unloading, two conveyors for end cap and tube handling, and unload chute for off-loading welded parts. Cycle time is 45 seconds per welded assembly (two separate welds, one at each end of tube.)

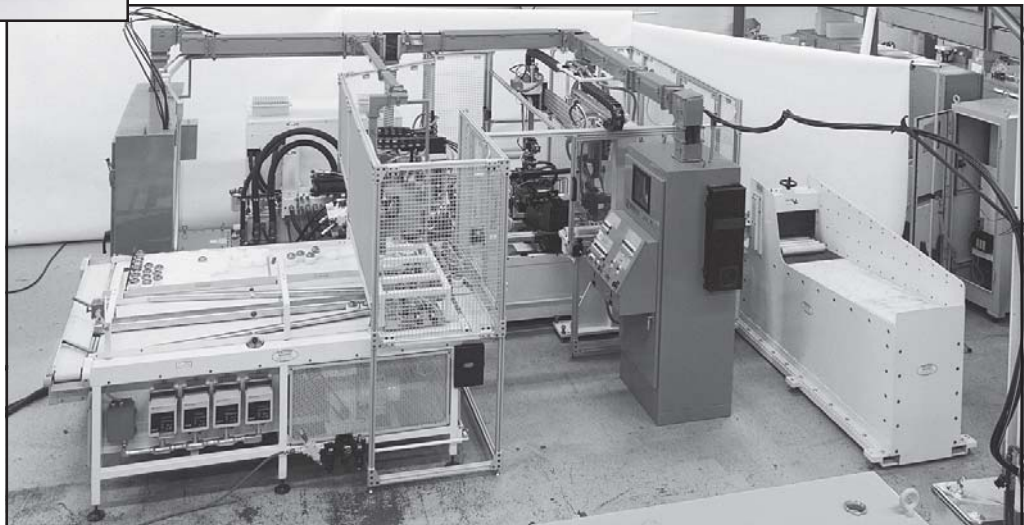

This twin welder has two independent spindles and fixtures to weld two solid ends to a hollow tube simultaneously. This welding cell includes automated spindle and fixture loading, flash shearing, flash removal conveyor, and part unloading conveyor. Welded assemblies are ready for fabrication and finishing. Production rates (dependent on tube diameter and wall thickness) are 250–300 welded assemblies per hour.

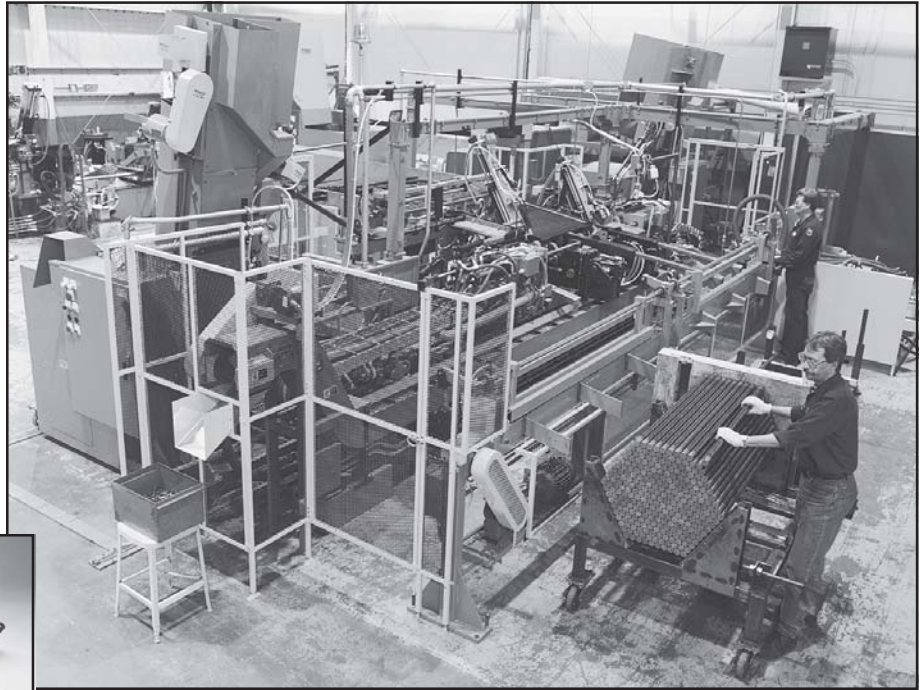

Model T120 Inertia Friction Welder

Used for welding automotive stabilizer bars.

Magnetic Impulse Welding

MTI has introduced a magnetic impulse welder to compliment its line of friction welders. Magnetic impulse welding is a solid state process that produces radial lap joints with parent metal strength. Two workpieces are placed in nonconductive locating devices, inside a continuous inductor. A bank of capacitors is charged to the desired level, and then discharged producing an extremely high rate of energy transfer to the inductor. The rapid rise in magnetic flux inside the inductor results in eddy currents on the surface of the outer workpiece. The eddy currents are then repelled by the inductor, resulting in a compressive radial force similar to that produced in explosive bonding. The outer workpiece impacts the inner at a very high velocity, resulting in a metallurgical bond.



Inertia Welder Machine Models & Capabilities

Different combinations and modifications are possible. All machines can be equipped with automatic load and unload devices, flash removal, and quality control machine monitors. All weld speeds are variable from 0 to maximum.

Model	RPM (Max.) Variable	Max. Flywheel lb-ft ² • kg-M ²	Max. Weld Force lb • kN	Max. Tubular Weld Area in ² • mm ²	Version
40	45,000/60,000	0.015 • 0.00063	500 • 2.22	.07 • 45.2	B, D, V
60	12,000/24,000	2.25 • 0.094	9000 • 40.03	.66 • 426	B, BX, D, V
90	12,000	5.0 • 0.21	13,000 • 57.82	1.0 • 645	B, BX, D, T, V
120	8,000	25 • 1.05	28,000 • 124.54	1.7 • 1 097	B, BX, D, T, V
150	8,000	50 • 2.11	50,000 • 222.4	2.6 • 1 677	B, BX, T, V
180	8,000	100 • 4.2	80,000 • 355.8	4.6 • 2 968	B, BX, T, V
220	6,000	600 • 25.3	130,000 • 578.2	6.5 • 4 194	B, BX, T, V
250	4,000	2,500 • 105.4	200,000 • 889.6	10 • 6 452	B, BX, T, V
300	3,000	5,000 • 210	250,000 • 1 112.0	12 • 7 742	B, BX, T, V
320	2,000	10,000 • 421	350,000 • 1 556.8	18 • 11 613	B, BX
400	2,000	25,000 • 1 054	600,000 • 2 668.8	30 • 19 355	B, BX
480	1,000	250,000 • 10 535	850,000 • 3 780.8	42 • 27 097	B, BX
750	1,000	500,000 • 21 070	1,500,000 • 6 672.0	75 • 48 387	B, BX
800	500	1,000,000 • 42 140	4,500,000 • 20 000	225 • 145 160	B, BX

Direct Drive Machine Models & Capabilities

Different combinations and modifications are possible. All machines can be equipped with automatic load and unload devices, flash removal, and quality control machine monitors. All weld speeds are variable from 0 to maximum.

Model	RPM (Max.) Variable	Max. Forge Force lb • kN	Max. Solid Diameter in • mm	Max. Tubular Weld Area in ² • mm ²	Version
7.5T, FW	3,000	15,000 • 66.7	1.0 • 25.4	1.07 • 690	B, BX, D, T, V
10T, FW	3,000	20,000 • 89	1.13 • 28.7	1.43 • 923	B, BX, D, T, V
15T, FW	2,500	30,000 • 133	1.5 • 38	2.0 • 1 290	B, BX, D, T, V
30T, FW	2,000	60,000 • 267	1.9 • 48.3	4.2 • 2 768	B, BX, D, T, V
45T, FW	1,500	90,000 • 396	2.39 • 60.7	6.4 • 4 148	B, BX, T, V
60T, FW	1,300	120,000 • 533	2.9 • 74	8.0 • 5 161	B, BX, T, V
100T, FW	1,000	200,000 • 889.6	3.57 • 90.7	14.2 • 9 219	B, BX, T, V
125t, FW	1,000	250,000 • 1 112	4.0 • 101.6	17.8 • 11 523	B, BX, T
150T, FW	1,000	300,000 • 1 332	4.37 • 111	20.0 • 12 903	B, BX, T
175T, FW	1,000	350,000 • 1 556	4.7 • 119.4	23.5 • 15 161	B, BX
200T, FW	1,000	400,000 • 1 780	5.0 • 127	26.8 • 17 290	B, BX

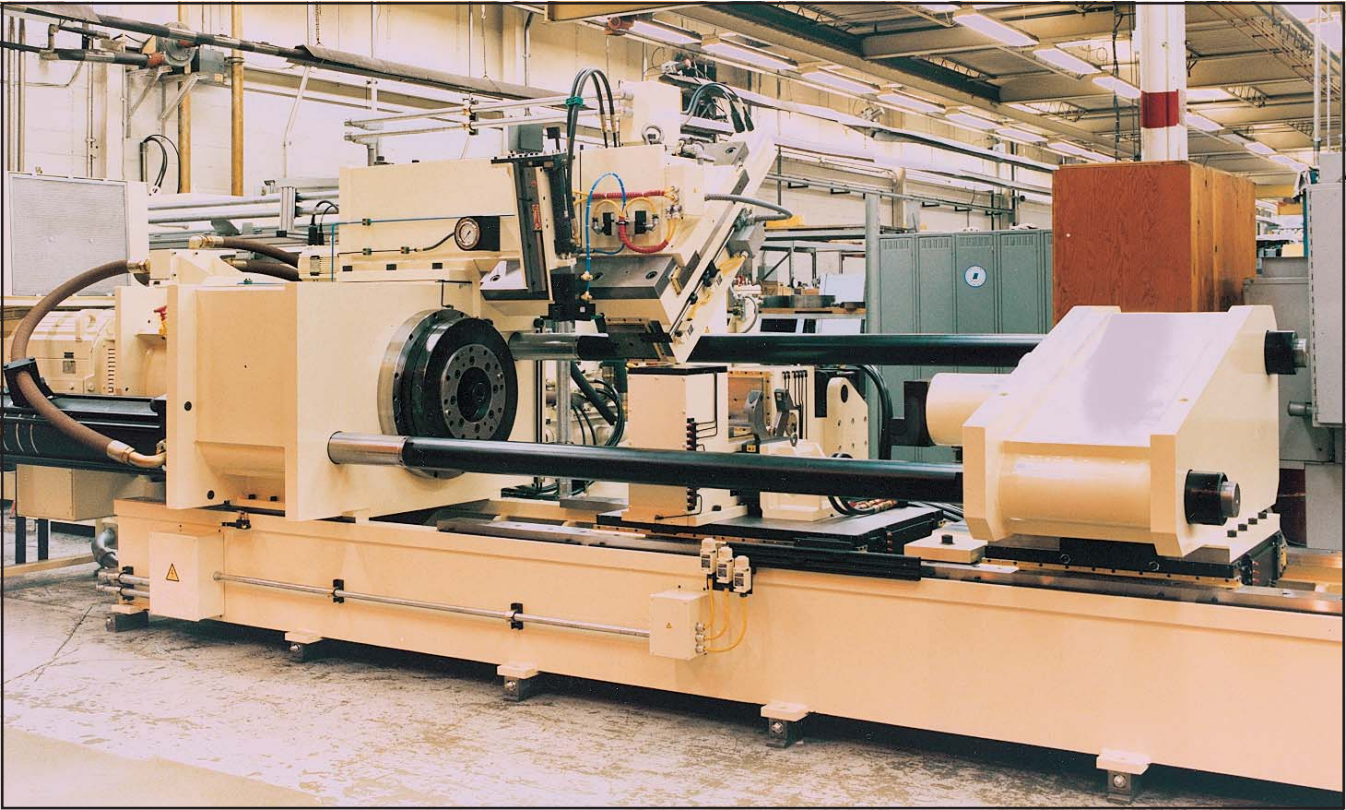

Model 200 Ton Direct Drive Friction Welder

Used to weld piston rods for large construction equipment.

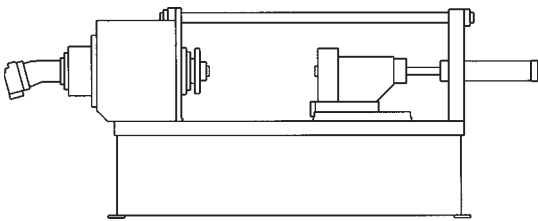

B (Box Style)

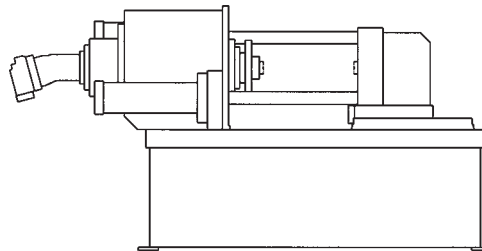

BX (Open Top)

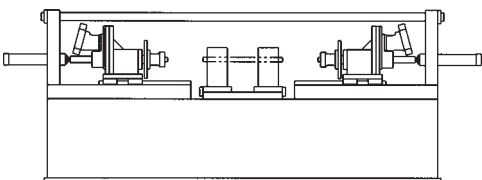

T (Twin-2 Spindles)

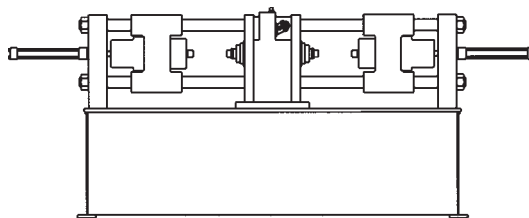

D (Dual-Center Drive)

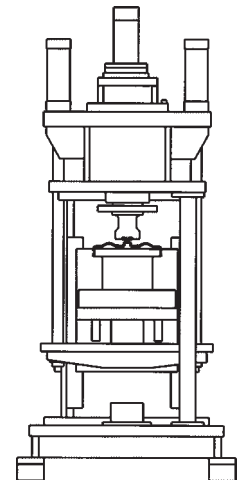

V (Vertical)



Model 15 TON Direct Drive Friction Welder

Used to weld airbag components.

Model 35 TON Direct Drive Friction Welder

Used to weld bearing housing retainer for transaxle.

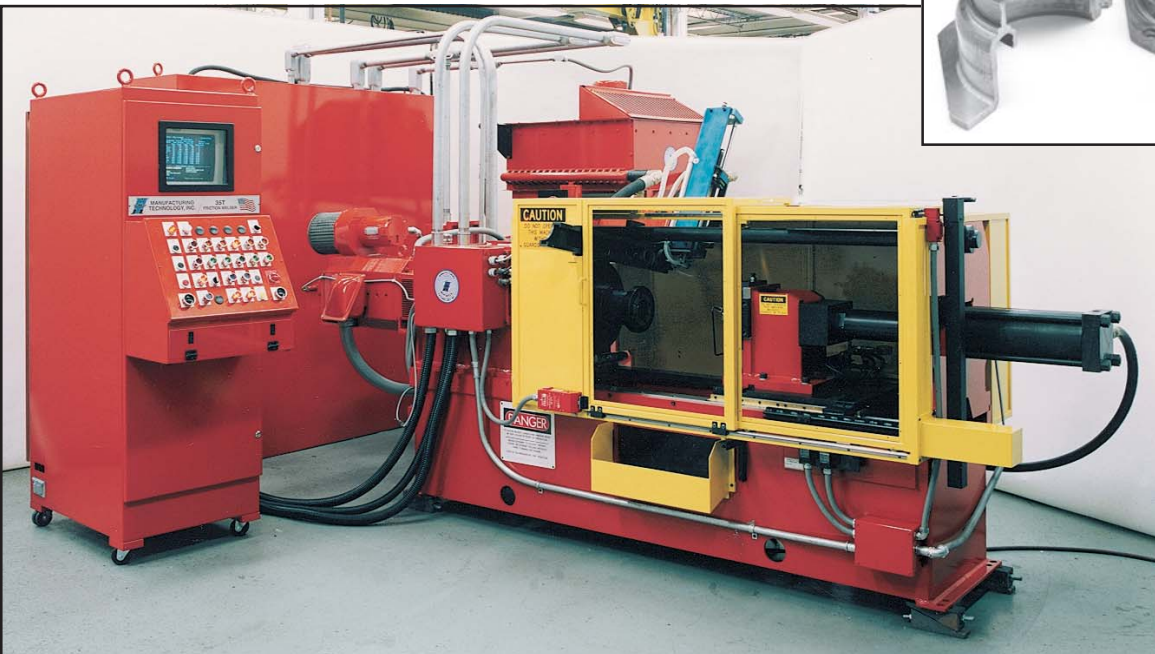



Model 180B Inertia Friction Welder.

Used to weld flywheel ring for outboard motor.



Model 180 Vertical Inertia Friction Welder

Used to weld airbag components.





Model 40B Inertia Friction Welder

Used to weld heat tubes for satellite applications.



Model 90B Inertia Friction Welder

Used to weld engine valves.



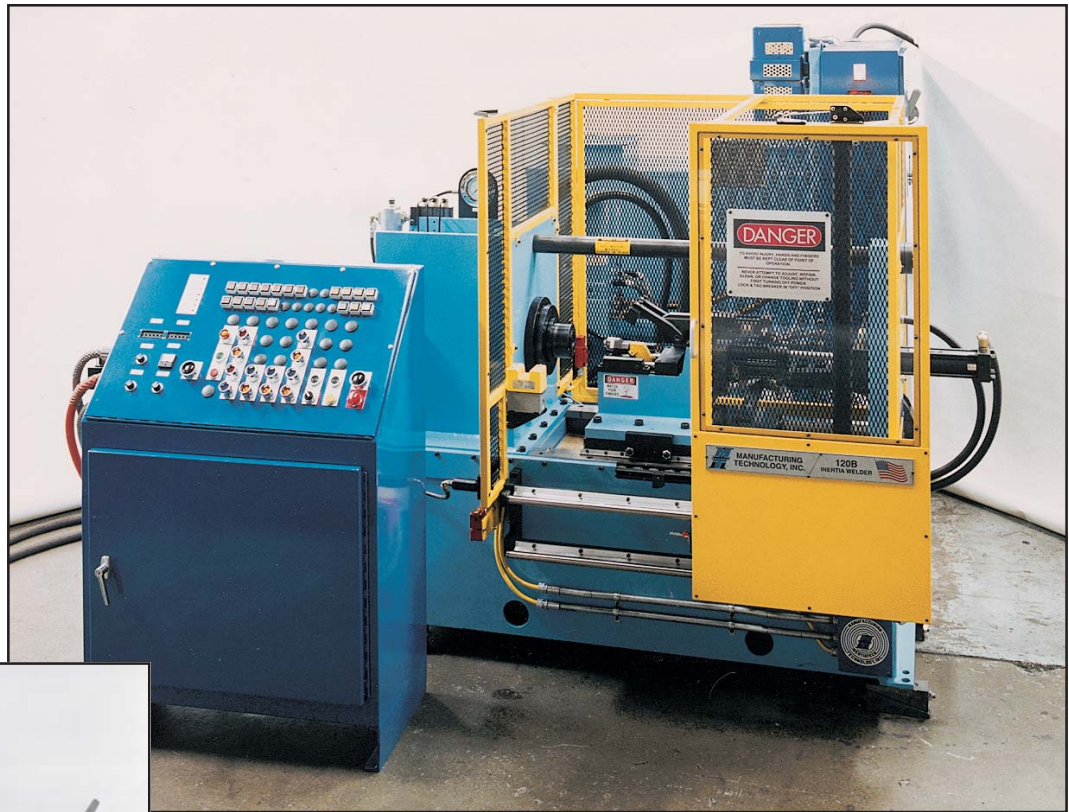

Model 120B Inertia Friction Welder
Used to weld automotive air conditioning components.

Model 120B Inertia Friction Welder
Used to weld turbochargers.





Model 45 TON Direct Drive Friction Welder

Used to weld stainless to carbon steel pump shafts.



Model 60 TON Direct Drive Friction Welder

Used to weld axle tubes to forged flanges.





Model 250BX Inertia Friction Welder

Used to weld valve bodies.

Model 250B Inertia Friction Welder

Used to weld diesel engine pistons.



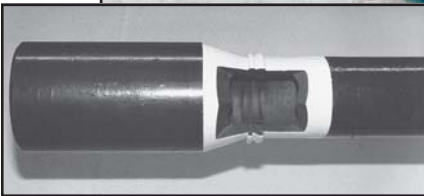

Model 320BX Inertia Friction Welder

Used to weld oilfield drill pipe.



Model 480B Inertia Friction Welder

Used to weld aircraft components.

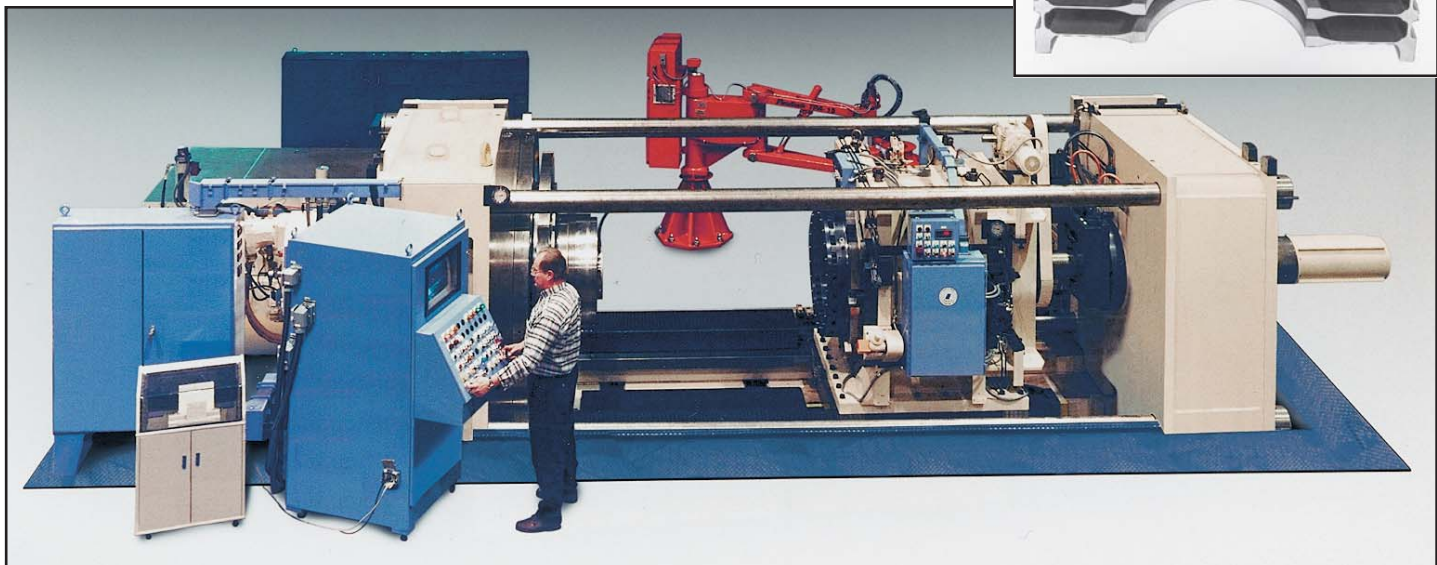



Model 800B Inertia Friction Welder

Used to weld jet engine components.



World's Largest Friction Welder

MTI builds the largest friction welders made today. The first of these 2,000-ton axial machines, built in 1991, was designed to weld aircraft engine alloys and components. MTI is the only manufacturer of large friction welders over 300-ton capacity.



Manufacturing Technology, Inc.

1702 W. Washington Ave. • South Bend, IN 46628

574-233-9490 • Fax 574-233-9489

Email: info@mtiwelding.com

Website: www.mtiwelding.com